

know your place

headmap

location aware devices

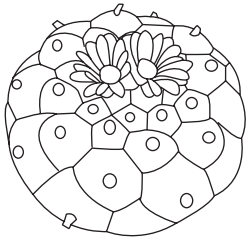
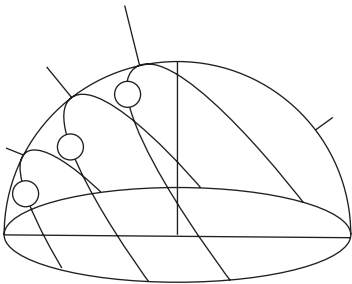
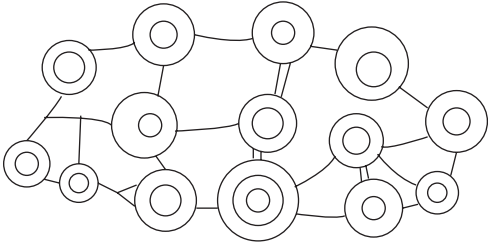
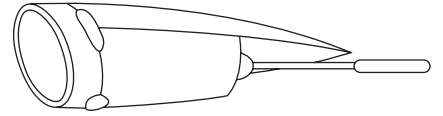

localisation . community and spatial interfaces . location aware devices . nomads . mapping sex . future architecture (life without buildings) . unlearning . new geography . community schisms . waypoints



headmap  redux

Contents

introduction

know your place	
background	
the geomesh	
new world	
inertial navigation	
street lights functioning as wireless mesh network nodes	
location aware devices	
internal models	
plasticity	
intersections	
nodishness and spatialness	
location aware emergence	
closest friend	

social software and spatial interfaces

localis(z)ation

essential interfaces	
digital objects and creatures	
different meanings	
invisible architecture	
seeing the space differently	
counter culture precedent	
localisation	
spatial and social exploration	

community and spatial interfaces [soft architecture]

community and spatial interfaces	6
spatialising despatialised communities	6
knowing where they are	6
location aware possibilities	6
localising technology	6
new ways to mark, demarcate and annotate space	6
symbolism and utility spectrum	7
utopian, distopian, inevitable	7
real life	7
new ways to relate to each other and leverage and extend the possibilities for local community	8
new ways to formalise the sharing and exchange of non monetised latent value	8
moving from a web model to an externalised identity model	9
filtering, reputation, trust systems and infomediaries	9
architects and their machines for living in	10

semantic web interfaces

point of view is worth eighty i.q. points	10
concept mapping [tinderbox view]	10
interfaces to the semantic web	12
the paragraph of text	13
back to the oral tradition through skywriting	13
gysin, burroughs, cut ups and knowledge management	14
the ancient art of memory and architectonics	14
the connections between things more interesting than the individual things	2
context aware applications	2

augmented capitalism

freedom ants	3
the declaration of interdependence	3
scarcity and greed	5
capitalism hasnt failed	5
equity	5
products	5
house shops	6
community transactions	6
object orientated retailing	6
right now there are a finite number of digital watches	6
value	6
rabid change in the techno economic subsystem	6
free stuff	6
micropayments	6
auctions	7
markets and funding	7
olmecs	7

new carburetor

new carburetor	7
misunderstood technology	7
..the nineties resemble the twenties	7
interfaces for human beings	8
psychological time	8
shining metal	8
gropius	8

getting outside

facilitating community	8
proximity	8
mechanically regulating community	9
seemingly innocent english villages	9
double meanings [howard hughes hitch hiking]	9
the richest most satisfying playground	9
the space program	10
signs	10
augmentation precedents	10
persona vitrea	11
senses	11
the flat sided deep	11
incompleteness	11
i trust it more than my eyes.	11
place the organising principle	11
email	11
information reconfigured according to context	11
the observer at the center	11
contingent on the interests of the beholder	12
the tyranny of categories	12
the observer augmented	12
behind the next hill	12
guides	12
degenerates	12

geomesh infrastructure

wireless networking as a precursor to augmenting	13
connect everything to everything	13
semantic reality	13
the expansion of the highway system	13
internet is not the same as freeway	13
coordination and support of field operatives	13
military origins	14
the ally	14
instant tools	14

mesh networks politics and law in software

software as constitution and law	14
linux	15
addapt	15
chess	15
the landmark lessig ruling	15

social organisation

twelve principles of collaboration	17
heterarchy	18
a new dominant form of social organisation	18
the network is the new dominant form of social organisation	18
society as shelter	18
domestication of grains made possible living in cities	18
community as value proposition [men are better than gates]	19
peer to peer companies, klogs and blogcliques	19
transcend mob mentality [stig quote]	20
howard rheingold barcode observation	20
mapping companies	20
corporations as robots	21
community	21
classification	21
despatialised community	22
cryptographically secure communities	22
actors	22
outsiders	22
free cities	22
a typical nomadic band consists of...	22
real communities brought together or sustained by the net	22
conferences as temporary communities	23
logistics	23
addressing	23
augmented logistics	23

soft architecture

23

new architecture

23

journey architecture	23
new architecture	23
path and place	24
lost cat	24
real space [outside versus inside] [augmenting reality vs simulating it]	24
abstraction and empty space	24
city images	24
aborigines	25
wayfinding	25
the discovery of culture in other animals	25
brutus	25
the landscape serves as a vast mnemonic system [and plays a social role]	26
skateboard	26
mental maps	26
athens	26
utopia [a]	26
utopia [b]	26
dreams shaping reality	26
pilgrim	27
cathedral theory	27
wooden cathedrals	27
ritual	27
synaesthesia through augmentation	28
simulation and augmentation	28

storytelling	28
dunne and raby	28
artist engineering	29
walk home	29
magical associations can inhibit if they lack flexibility	29
storage and retrieval city	29
soft architectures	29

lost spaces

30

definition of architecture	30
a new form of parasitic architecture [augmentation as]	30
optimism in architecture	30
human beings are nomadic at a very fundamental level	30
mnemonic architectures	30
psychological projection [its not really there]	30
sacred space	31
a locus is a place easily grasped by the memory	31
the new world	31
voyages of discovery	31
voyages, navigation and the extension of knowledge	31
new worlds inspire hope and new ways of thinking	31
memory maps and symbol systems [organising and structuring]	31
most architectures exhibit both process and mnemonic aspects	31
physical buildings function on many levels	31
clay grahams symbolic arrays	31
a cathedral is a symbolic clearing in the woods	32
using archetypes to convey the purpose of a space	32
temporary architecture	32
the myths and rites constitute a mesocosm, a mediating, middle	32
cosmos	32
trees	33
tree of life	33
how religions work	33
visualisation should help people interpret information	33
the collective consciousness	33
culture	33
cultures give shape to worlds	33
simulation and politics	33
scientific annotation	33
space as hierarchy of values replaced by space as a system of	33
magnitudes	33
gallileo	33
the ability to think rationally is pretty rare	33
cartesian systems plus emotion	34
augmenting reality	34
not so much a dwelling as a memory machine	34
crenellations and slit windowed towers	34
lions and unicorns	34
externalising the internal	34
memory theatre	34
syncretism	34
apple and cabala	34
language	34
the intuition of space	34
evolution	34
synaesthesia	34
lost spaces [better use of lost spaces]	34
rooms adrift	35
existence is everywhere	35
secede	35
our time	35

land [implicit boundaries]

35

implicit boundaries	35
---------------------	----

a magical legal function	35	just going [one american dream against another]	43
the railroads, the steel plough, the six shooter, steel windmills and barbed wire	35	old people interfaces	43
parceling up land into rectangles	35	mall fortresses	43
change	35	acid steps	44
recolonise the usa ignoring old structures [overlay a new pattern]	35	campus defense	44
parasite responsibility	35		
they colonise you back	36	situations	44
flowlines	36	situationist international	44
open source language	36	leaving the twentieth century	44
the question of land refuses to go away	36	the transformation of reality itself	44
athens	36	modern fiction	44
narrative has always been subservient to the tangible	36	formula for a new city	44
space folding	36	to play with time and space	45
escape valve	36	only in the possibilities	45
sleep late	36	drifting and psychogeography	45
control	36	the new technologies of conditioning	46
land as a central tenet of modern power structures	37	the construction of situations	46
civitas and urbs	37	formula for a new city	46
nomadic	37	unitary urbanism	47
temporary autonomous zones	37	not just the cops and the geometry	47
pirate networks	37	bear speech bubble	47
meaning trees	38	the boundless energy trapped under the surface of everyday life	47
the survey of india	38	an economy based on desire	47
maps [borders and boundaries]	38	refuse for any reason whatsoever to return to earth	47
uncharted territory	38	lloyd george	48
colonial cartography	39	de sade	48
bookmarking the oceans	39	they left	48
psycho	39	mapping sex	48
		spatial and social weirdness	48
logical	39	sexual geographies	49
		shoes	49
geography	39	g spot	49
		sun and moon medicine	49
surplus futures	39	angels	50
poverty as a relief [knowing where the ground is]	39	mapping faith	50
heater	39	faith is a placeholder	50
honey	39	the wheel	50
so much	39		
essential goods	39	maps	50
poverty, wealth, satisfaction	39	new ways of seeing [science as a sequence of maps]	50
leave your shoes at the door	40	the whirlwind tour of modern mapping	51
home	40	machines for generating interpretations	51
one general theory of america goes like this	40	a way of seeing the world differently	51
san francisco	40	can be structured but it is never structured definitively	51
		generate different meanings	51
new geography	40	songlines	51
new geography, new internet	40	aboriginal conception of space	51
haircut	40	footprints	51
improvising in the new territory	40	dogs	52
a cultural geography	41	trackers [information about those people]	52
plasticity of externalised meaning	41	server logs	52
out of place	41	human beings as pattern following creatures	52
landscapes have a biography and are authored.	41	institutions	52
marigold	41	patterns in behaviour	52
cultural geography focused on resistance.	42	human patterns have become commoditised	53
fear geography	42	showing people there patterns rather than using them as sales tools	53
travellers and the rural idyll	42	extension of digital patterns and logs into physical space	53
patterns of spatial resistance	42	sell your morning walk	53
tramps	43	seti and solloway	54
insurrection	43	rooms with histories	54
		transience and fragility	54
		a world filled with notes and objects that arent really there.	54

secede from the present	54	making the stone stony	65
surface boy, surface girl	54	churinga [temporary and permanent]	65
implicit rather than explicit	54		
gps data streams [eben moglen and immaterial incorporated]	55		
no guarantee of liberatory use of tech	55		
liberation and destruction	55		
social control [police sensorium]	55		
weatherman one	55		
commercial satellite imaging	55		
popular culture and technology to keep people grinning mindlessly [virgin]	56		
social control through information	56		
a salesman had been placed between americans and life	56		

magic(k)al tech

magic[k]al tech definition	56
hyp[er]nosis	56
empirical limitations and ehancing the senses	57
trance, suggestion, set and setting	57
the original captain trips	57
build your way out	57
magickal tenets	57
the meta belief that belief is a tool	58
magicians dealing in abstractions	58
brain valve	58
the brain valve and the ego filter	58
magick, soft forms hard forms	59
the observer affects the outcome	59
magick as heuristic	59
changing infrastructures	60
gnosis	60
art objects	60
hypnosis	60
...ritual	60
divination	61
mesa [power objects laid out on the ground]	61
five classical magickal acts	61
shamanism	61
curandero	62
ways of thinking and learning	62
a tribe called the mericans	62
evolution of magic[k]al technology	63
magick vs cellphones	63

dreams

cooking	63
life flows into inanimate objects	63
gods for everything	63
every culture lives within its dream	63
collective dreams as structuring agents	63
to make dreams truth and fables histories	64
are there plants?	64
does a firm persuasion of a thing make it so?	64
a new cathedral	64
ideas trying to come into being	64
merely trying to occur	64
ideal engineers	64
the planetary mind	64
nodishness and spatialness	64
mythology made alive	64
the erotic nature of automated universes	65
divides	65
framing and annotating nature	65
beauty outside	65
yugen	65

56

men are better than gates	68
community as exoskeleton	68
elements of a religious cult	68
subversiveness networks	68
non state actors	68

network conflict resolution

66

my god i dont want that	66
social self organisation	66
location based services for homeland security	67
balance between the liberating and controlling aspects of technology	67
local law	67
states and companies with computers vs individuals with computers	67

fighting technology

69

military monastics	69
let slip the toys of war	69
men are better than gates	69
the c[on]j[ur]isr architecture	69
cu chulaind	69
indistinguishable	70
who says the streets are reality?	70
never at the hot gates	70
sixteen thousand tons of pure symbolism	70
military monastics [armies as communities]	70
[seekers][keeney meeny][warrior pilgrims]	70
i looked for death	70
future war	70
business metaphors	71
halo	71
no profit	71
endless	71
at least half of them secondary school and college graduates	71
antidiplomacy	71
war universe	71
deep black	71
superfortress	71
into battle with standard office equipment	71
under the carpet	71
watch for gaps and slack	71
the fall of empires is always dangerous	71
the lowest quality image, the highest representation of reality	72
smart bombs	72

63

under the carpet	71
watch for gaps and slack	71
the fall of empires is always dangerous	71
the lowest quality image, the highest representation of reality	72
smart bombs	72

conflicting values

72

your word	72
grifter	72
working	72
belief	72
builders	72
fear	72
stowaway	72
history	72

counter culture research

and development

73

counter culture research and development	73
experimentation	73

continuity	73	chemical anchors	88
trace root	73	seeming vs being	89
exploration	73	absorption	89
haight	73	khaosan road	89
the red dog saloon	73	reality	89
seekers	73	kash	89
william burroughs	73	a new form of difference	89
playpower	74		
the superficial aspects	74		
keep moving	74		
temporary doctrine	74		
temporary, like concerts, and not enduring like the pyramids	74		
diggers [free cities]	74		
turnips	75		
the underground press	75		
underground media	75		
from communes to open source	76		
etymologically perhaps	76		
rethinking land	76		
heuristics	77		
intentional communities	77		
the hippy trail	77		
dialectic	77		
the road to kathmandu	77		
out	78		
lonley planet	78		
third world networks	78		
future orientation	79		
three days	79		

temporary autonomous zones

temporary autonomous zones	80
secular religion [plus electronica]	80
insurrection has festive aspects	81
festivities often border on insurrection	82
the free festivals	82
convergence	82
the point at which you hit the highway on the way out.	83
some existentialists are not plant people.	83
a typical nomadic band consists of	83
yesterday and tomorrow	83
protest	83
zapatistas	84
netwar and zapatista note	85
rug mobs	85

drugs and the built environment

getting back down	85
castenada	85
drugs and the built environment	85
inside	86
opiates	86
straight	86
Where Everything Comes From	87
amoeba knowledge	87
a chemical shock	87

dissent

the countercultural idea has become capitalist orthodoxy	87
dissent	88
tom frank	88

prototyping future community

experimentation continues	90
charred coughing phoenixes	90
desirability	90
gropius [again]	90
marble well governed cities [again]	91
shape of the system	91
most minds	91
space hardware	91
so	91
availability	91
geography as context and constraint	91
geography doesnt matter	91
i need a sandwich	91
mass market wearable hardware	92
by adding geographical awareness to the internet you create something new	92
wanting [emotional archaeology]	93
wireless castenada	93
society is actively looking for new ways to organise	93
a united states, freedom, representative democracy	93
the new economy	93
reinterpreting anarchy as a positive and constructive relative of heterarchy	94
prototyping future community	94
better ways	94
revision note	95

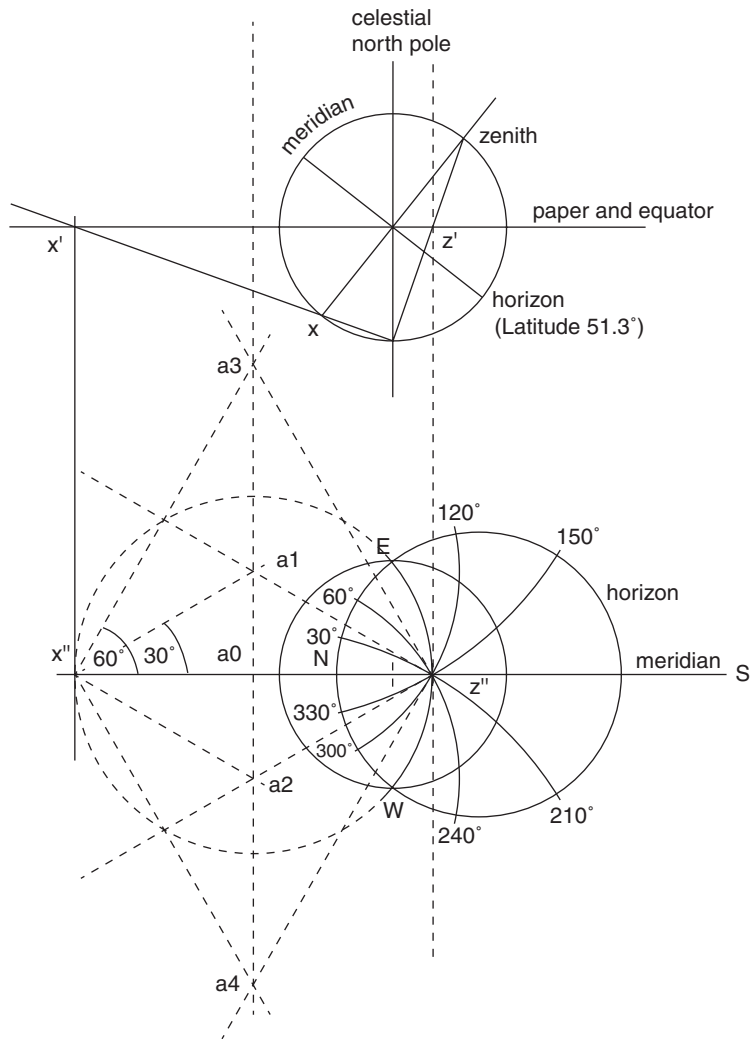

wearable computing, retinal displays, distributed wireless mesh networks and semantic web standards are the foundation of an outside internet. The space, the social network, thinking tools and the network interface in the same field of view. The boundaries between what is interior and what is exterior intersecting tangibly in front of your eyes.

It has been said that 80 percent of human knowledge has a spatial aspect - yet at the same time the Internet has largely ignored this. We are human beings; embedded in and subservient to the spatial and temporal limitations of a physical reality. The Internet should soon be able to reflect these realities better.

introduction

know your place

there are notes in boxes that are empty

every room has an accessible history

every place has emotional attachments you can open and save

you can search for sadness in new york

people within a mile of each other who have never met stop what they are doing and organise spontaneously to help with some task or other.

in a strange town you knock on the door of someone you don't know and they give you sandwiches.

paths compete to offer themselves to you

life flows into inanimate objects

the trees hum advertising jingles

everything in the world, animate and inanimate, abstract and concrete, has thoughts attached

background

The headmap manifesto is a sequence of text fragments dealing with the social and cultural implications of location aware devices.

Headmap argues a move from the 'inside' view that developed after the failure of the space programme, the closure of the frontiers, the rise of television, early computing, interiorised simulation and drug culture..

..towards an 'outside' view - a recolonisation of the real world, computers becoming invisible, mobile, networked and location aware, the real world augmented rather than simulated. People finding more outside than inside and developing sophisticated information based relationships to exterior spaces, computer games moving outside, technologies facilitating the tagging and annotating of spaces, places, people, animals and things, the emergence of new forms of spontaneous externalised real social interaction, constructs drawn from dreams and myth shape the outside more tangibly than ever before.

New forms of collective, network organised dissent are emerging. Collectively constructive rather than oppositional. Now capable of augmenting, reorganising, and colonising real spaces without altering what is already there or notifying those being colonised.

The internet has already started leaking into the real world. Headmap argues that when it gets trully loose the world will be new again.

the geomesh

a geomesh

Presence on a local wireless network is becoming a usable indicator of spatial proximity (for machines and people). GPS systems can supplement this less formal geocentric interaction by providing accurate information that can be disseminated through the local network (but they don't necessarily need to).

wireless nodes can broadcast RDF feeds containing location information [cf consume]

wireless heavy conferences are early forms of working social geomeshes, the location of participants is constrained and a wireless communication channel is open. The geosocial organising principle is the intersection of the conference (representing both place and common interest) and wireless network, if you're associated at the conference and on the network you're most likely connected spatially, socially and ontologically.

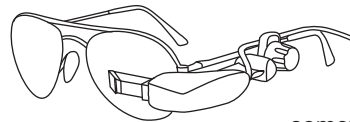

new world

The linking of a location aware device (e.g. something with GPS functionality), with a handheld computer (e.g. an IPAQ or a handspring) together with a mobile, wireless, internet connection, creates a significant new mass market computing platform which begins to make possible:

- leaving notes, demarcating spaces, and marking places, but leaving no external visible sign of having done so.
 - anything left can be made visible to all, or to user specified individuals and groups.
 - information (textual, audible or visual) can be bound to specific places.
 - an alternative or supplement to permanent visual signifiers (e.g. signs, clothing, advertising).
 - individuals can utilise new forms of community based on augmented awareness of their proximity to places of interest and each other..
- ..spontaneous extended community defined by both common interest and proximity.
- tracking the migration and movement patterns of people, animals and things.
 - places can have histories 'attached' to them (i.e. the collection of notes left at a given place sorted according to when they were left).
 - inanimate objects can become more animate (if you know where

a tree is and you know when someone is walking past it you could make it burst into song).

inertial navigation

..there are even Integrated MicroElectrical Mechanical Systems (IMEMS) techniques which are making possible the fabrication of chips with onboard digital compasses, and, more interestingly, gyroscopes and accelerometers (which means that the kind of inertial navigation systems used to navigate nuclear submarines without breaking radio silence can be embedded inside your cell phone)

Location aware devices.

street lights Functioning as wireless mesh network nodes

“As cable companies continue to increase the cost of broadband service, and as telcom monopolies are strengthened by changes in FCC policy, it is now absolutely clear what the broadband endgame will be in the US: wireless. Think of a city where every single street light is a node in a mesh (for an example, see meshnetworks), and thus where the cloud of the internet sits on the street like the fog in San Francisco. For almost nothing, cities could provide IP light, as cities provide street lights. Neutral, end-to-end, fast, and cheap.”

lawrence lessig

location aware devices

location aware, networked, mobile devices make possible invisible notes attached to spaces, places, people and things.

the headmap manifesto articulates the social implications of location aware devices.

It manifests a world in which computer games move outside and get subversive.

Sex and even love are easier to find.

Real space can be marked and demarcated invisibly.

..what was once the sole preserve of builders, architects and engineers falls into the hands of everyone: the ability to shape and organise the real world and the real space.

Real borders, boundaries and space become plastic and maleable, statehood becomes fragmented and global..

Geography gets interesting

Cell phones become internet enabled and location aware, everything in the real world gets tracked, tagged, barcoded and mapped.

Overlaying everything is a whole new invisible layer of annota-

tion. Textual, visual and audible information is available as you get close, as context dictates, or when you ask.

internal models

The blurring of the boundaries between interior and exterior, the real and the virtual, foreshadows the formal acknowledgment of the space at the intersection and the extent to which that intersection can now be tangibly manifested and manipulated.

internal models are slipping out into the world like agile, colourful, and communicative ghosts. The same ghosts of our intent that traditionally emerged heavy and quiet in concrete and steel, or just as agile as their modern counterparts, but bound to paper and travelling slow and disconnected.

no need to stop and look at the map, the map overlaid on the space, and in the same field of view, will no longer be separable from the space.

..assumptions etched on our eyes

plasticity

In the sixties mathematics was animated in your head or in mechanical forms, heavy metal and concrete and steel were marveled at for there combined plasticity and the speed with which a building made of them could be conceived of and built

the more we integrate agile and manipulable externalised maps with our normal field of view, the more exposed the connection between the internal and the external becomes.

there is a more tangible sense of the interaction between internal maps and external reality

we will no longer ‘stop to look at the map’ reinforcing the split between interior and exterior, the map and the territory will be tangibly integrated in our field of view

as without so within

intersections

a headmap is bound up with the feedback loop when something internal is externalised, seen simultaneously in the context of external reality, manipulated in that context, and reinternalised

evidence of the intersection between outside and inside [real and virtual], the formal acknowledgement that something outside came from inside

until recently world and brain, physical and mental [mind and body], have been easy to see as split instead of intersected

is it real or is it virtual is the wrong question

Technology is rapidly facilitating the externalising of the interior journey of the last 30 years [drugs, computing, electronic media, network culture]

temporaryness and maleability makes internal outside more

apparent..

..a building is less obviously externalised interior because of its permanence and imovability

..from magick, ritual, mathematics, logic, tarot, mnemonic architecture and theatre, drugs, maps, books and songlines

..to tinderboxes, gps, mesh networks, shimmering mnemonic architecture and theatre, drugs, networks, magickal suggestion, temporary and spontaneous culture and unlearning

we are beginning to see agile manifestations of our internal models moving and tangible in front of our eyes ..pliable and manipulable them, change them and take it back inside.

chemical maps, digital maps, architectural maps, narrative maps, symbolic maps, scientific maps, psychological maps, economic maps, social maps, diaries, learning maps, future maps

a road is a real thing, but it emerged from human intent (whether carved out by thousands of feet or forced through by civil engineers. Its origins are internal and its manifestation is a practical reality.

what was inside projected outside, something coming from inside clarified outside, an external manifestation that now acts on our interior model of what real is

theatre is a map that triggers meaning, as is architecture, as are books and computer screens and social networks

..drugs are a projection of personal deconstruction, and the capacity of drugs to alter our experience of and response to reality is bound into the possibilities of wearable technology

so many possibilities are close to the surface, reality is tangibly collective collaborative experimental modern fiction

nodishness and spatialness

[ambient calculus for humans]

nodishness is about the boundary between the personal and the collective

..the boundary between personal extension of self and the collective interconnected extension of us

noone is an island and noone isn't

you preserve extended personal boundaries and don't exist alone

...pushing the limits of seperatenss and dynamic connectedness

adhoc-corporate but still cellular

we had a network of static machines and moving people ..now a significant part of the machine network is moving as well - moving personal devices attached to people

you, your mobile device your weblog

but all these chosen personal extensions are designed and optimised to exist in a network of similars

..pushing chosen perceptible boundaries that are permeable, open, and connected

with technologies like rendezvous and open 802.11 nodes emerging from broadband + wireless you're not the edge anymore, you're the way out for someone if you find the way out

..or just a source of interesting mp3's while you're in the same space

there is a layer of the network which is now dynamic, adhoc, impromptu and moving

and to that layer, proximity and spatial issues are important. While we are reliant on radio transmitters and current technology, it matters how far, and whats in the way ..and because we're moving we want to know about where we are and we want to find cool stuff here real or informational

analysis of the interrelations between weblogs shows people accepting and understanding their nodish fate in ever greater numbers. Linking in every direction and accepting links from every direction in a link economy.

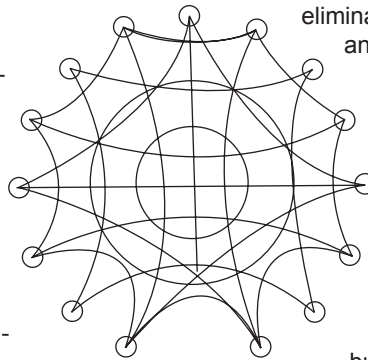

eliminating the distance between the physical self and the digital identity will result in other forms of exchange beyond links

blogs are still stuck things

no reason why your network identity should be stuck so far from your physical identity

its one thing to attach geographical coordinates to a blog

but why not just go the whole way and have an abstract interface to your personal self beyond your clothes and how good your breath smells

in spatial terms, you're already going to be walking around with ports essentially visible (whether open or closed). When someone electronically sniffs the air in the room you happen to be in they see your devices whether you let them access them or not.

you're not far from having to consciously think about the electronic signature you're giving off

its likely to end up being something more than nokia or sony

..what kind of nodishness do you aspire to

whats your interface like ?

the physical distance between you and your digital identity is likely to decrease very rapidly

the pure abstraction of the internet is very attractive but the plain fact is that we are active parts of the network and essentially earth bound spatially orientated beings. Instead of disappearing into the world of bits anytime soon the world of bits is going to have to come out into the world.

..really it goes both ways, as we accept our fate and get on with

being mobile nodes

people are nodish in themselves: bounded but connected..

weblogs are personal spaces with nodish qualities..

Mobile devices are very personal devices, and nodish, the proliferation of 802.11 and bluetooth built into these devices make mobile users walking infrastructure for mobile adhoc networks

“Mobile adhoc networking allows users to exchange information in a wireless environment without the need for a fixed infrastructure. Each user (or node), equipped with one or more radios, is free to roam about while communicating with others. The path between any pair of users can traverse multiple wireless links and the radios themselves can be heterogeneous, thus enabling an assortment of different types of links to be part of the same adhoc network.” [from a mobile mesh website]

mobile adhoc networking technologies (like apple’s Rendezvous) are realising and resulting in personal impromptu networks, sometimes connecting to wider networks, sometimes just to the people and devices in a particular room (maybe just sharing music or collaboratively working on hydra headed documents).

People: aware, processing, recording, disconnecting, moving, searching, connecting and retransmitting in collusion with their devices

more and more we (bound to our devices) are mobile nodes.

extended but bounded personal spaces existing in and facilitating networked spaces

external human interaction is more and more through this extended concrete and abstract personal space

nodishness

more and more, because of these concrete personal devices and these abstract blogish applications. You, extended you, but still you a bounded personal space (you a human.device.blog node) constitute a new thing walking the earth, traversing and creating

“The Internet has been at the forefront of the industry’s efforts for the past decade, but from a paradigmatic point of view, it was largely framed as an add-on to a personal computer. But now a personal computer is becoming part of a larger mesh of computers and devices that come and go, with a mesh of services that come and go, and application design is starting to reflect that realization. With Rendezvous, Apple has come up with a very, very simple architecture that I can see a lot of people leveraging.” Tim O’Reilly

nodishness mixed with spatialness

headmaps and smartmobs

the internet is a collective, heaving, ever changing map already, with everyone contributing a bit of what they can see.

..theres a linux quote that i can’t find that says something like using linux is like living in a house thats always being worked on, you wake up in the morning to find that someones built a really

cool extension out the back while you were asleep.

..an extensible metaphor that actually applies to the reality of the real world in general: really cool or really bad, you can bet someone built something while you were sleeping.

adding a spatial or geographical dimension to the internet is a natural and ongoing extension in the light of increased mobility and wirelessness.

but the result is that metaphors start slipping in all directions..

maps becoming a persistent visible feature of the place they happen to map.. so that you need to mark the maps on the map or you won’t see the place properly

Devices are aware (and becoming more so) of location, of people, of messages, of connectivity and other machines. The users handle the other half of the awareness. ..and they all rely on each other.

It follows from increased mobility that the benefits and possibilities that arise from formally tagging information with place references become apparent.

location aware emergence

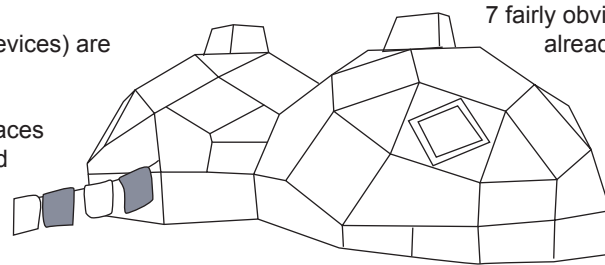

7 fairly obvious spatial/network capabilities that are already maturing and readily available.

- 1). using mobiles to coordinate people in the same space you cannot see e.g. “i’m in the carpark, where are you?” or using texting to coordinate antiglobalisation demonstrations (smartmobs).
- 2). personal diaries for recording and sharing experience (blogs) extending to mobile devices. Mobblogging (mobile blogging) with picture phones, handhelds and laptops. Mobile Phones have only recently become ‘one to many devices’, you can now text to a group or send a photo straight to a web page.
- 3). Finding out how to get where from where you are to where you need to be is easy using webmapping tools like streetmap and mapquest. These tools have mobile interfaces so you can use them from a phone or handheld.
- 4). web accessible databases of place information (restaurants or whatever), are already being used by mobile users through services like Vindigo and Yell. You don’t use GPS, you just enter a cross street or the local post code of where you are to find something close by.
- 5). Projects like Geourl are allowing bloggers to add tags to there web pages, that locate the blog in a particular place. This locates the conversations of bloggers. Paris bloggers, NYC bloggers, London bloggers. Tagging projects allow for adding location as a property to all kinds of web accessible information. UpMyStreet specialises in spatially locating conversations.
- 6). In car navigation systems are also becoming more common and even skeptics end up finding them really useful. GPS units can be bought for cheap, and are slowly being integrated into chips and phones and handhelds.

7). Because bluetooth and 802.11 allow local machines to talk to each other, if one of the machines knows where it is, they all can, and location information can be stored locally

Integrating all these capabilities gives you something new. Networks and shared information about places without a centralised mediator.

connect and integrate all this extant thinking and given the general trend towards nodishness you are going to get considerable spatial weirdness emerging.

The longer term possibilities are new forms of exchange, cooperation, spontaneous governance, fluid digital architecture overlaying real space (marking, connecting, bounding, guiding, and illustrating places), contextual computing, spontaneous interfaces to groups and spaces (people, playgrounds and tower blocks).

all increasingly possible (to the point of banality)

There's never been a clearer, more real and open, or more interesting opportunity to try to discern the patterns of, and then to provide maps, systems, models and prototypes for future community.

closest friend

You will be able to ask the question who is my 'closest friend' and get a numerical answer and a position.

social software and spatial interfaces

localis(z)ation

essential interfaces

There is a lack of essential interfaces to 20th century 'machines for living in' (housing projects and urban environments)..

Interfaces to local communities and local spaces are finally evolving after an extended period during which the development of communications technologies has focused on making proximity irrelevant. (global rather than local ..when does the next bus get here?)

- interfaces attached to buildings and empty spaces (for making better use of community spaces, sports fields, playgrounds etc).

- interfaces based on new opportunities for sharing and exchange (digital spatialised mediation of simultaneous need).

digital objects and creatures

digital 'objects' and 'creatures' attached to locations and spaces.

different meanings

Different people attach different meanings to the same space. Location aware devices make it possible to externalise these different views, make them tangible and share and extend them. (use the collective local cycle courier view of an urban space to find a short cut in an unfamiliar city).

invisible architecture

Location aware devices make possible: leaving notes, demarcating spaces, and marking places, but leaving no external visible sign of having done so.

This lays the foundation for a new subjective, invisible, instant architecture (new paths, new places).

seeing the space differently

Location aware devices will remove the inertia, the objective reality claim, and the stabilising influence of the built environment.

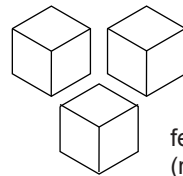

Location aware devices allow individuals and communities to see the space differently.

Society will continue to fragment as the once shared meaning of the built environment migrates into many different collective (subjective and invisible) views of the space (mediated by location aware devices).

Despite this new architecture being effectively invisible, the apparently out of context or 'out of place' human behaviour that will result will not be invisible.

Seeing the space differently may lead to radical social and political upheaval (the German 'blitzkrieg' was a consequence of a new spatial doctrine).

counter culture precedent

Counter-culture spatial and social exploration since the 1960's prefigures the opportunities for spatial and social reorganisation offered by location aware devices (temporary autonomous zones, the hippy trail, communal living, extra-geographical allegiances, collective construction, externalised word of mouth, new ideas about value and exchange).

localisation

"Space will change. Localization may happen. The US may run out of cheap petroleum eventually." Lawrence Angrave

Location aware devices make it possible to better leverage the space around you. To better integrate awareness of proximity into the extended communities (usually based on common interest rather than proximity) that have grown up around space folding technologies like the telephone and the internet.

This represents a technologically inspired interest in, and move towards, localisation.

spatial and social exploration

get free of the 'line of sight' labyrinth of streets and buildings

organise, augment and alter real spaces (add shapes, community and information to them)

drive cars that aren't yours and live in houses you don't live in

pay with what you have (even when you don't have money)

ask for what you want, or, how you can help, and walk to where the answer is

phone the things you own (ask your keys where they are)

find the people you need to find

community and spatial interfaces [soft architecture]

community and spatial interfaces

"There is as yet no new social framework that is as interesting as technology, and ideas, now allow."

There are new ways to organise, make sense of, and leverage, local spaces and local communities.

New interfaces to the real spaces that people move through and live in are now possible. Technology is creating an opportunity for communications to become less mediated rather than more mediated, to get people outside and increase rather than decrease real face to face communication.

spatialising despatialised communities

dislocating:

The internet lowered barriers to long distance communications and made distance and time independent community a real possibility for anyone with an internet connection.

The cell phone, pagers, email, fax machines, video conferencing, web sites, all enable us to conduct life efficiently at a distance from each other.

Communities can now be founded purely on common interest rather than spatial and temporal proximity.

relocating:

Making sense of local spaces and local communities is a problem that has been almost completely overlooked in all the efforts to make long distance communication easier.

There is a lack of effective interfaces to the spaces around us and a lack of tools specifically designed to facilitate local face to face community.

Knowing where they are

cell phones (which at least allow you to go outside) are soon going to know where they are.

Given that cell phones have already become indistinguishable from computers and that they now come with internet connections, the fact that they will know where they are is significant.

location aware possibilities

Portable devices that know where they are can coordinate. They can make sure that two people who are close to one another and ought to meet, do meet, they can tell a person what they need to know about the space around them, they can link up people with something to exchange (according to unconventional or conventional ideas of what is sharable or exchangeable).

The potential for unnecessary barriers between people (walls, streets, not knowing each other) to be lowered is increasing.

The space local to people can become less opaque, they can see their location in terms more sophisticated than their line of sight. They can see the space in terms of who and what are within a given distance from them.

Developments in communication, from newspapers, the telegraph network, and TV, onwards have focused on making distance irrelevant.

On allowing people to communicate, observe and participate in events, at a distance from them. But a new technological platform is evolving that can make sense of the space immediately around us in a radical new way.

localising technology

Knowing more about where you are is an obvious problem, but in digital technology terms it has only recently become deeply solvable (because we only just found ourselves with cheap internet connected cell phones that can know where they are).

Historically technology was about community and local orientation, maps, church bells aligned to clocks for community time keeping, and astrolabes and sextants for star navigation were all significant technological enhancements grounded in making better use of local space and time.

new ways to mark, demarcate and annotate space

As well as facilitating direct contact between people, location aware devices will allow people to invisibly mark, demarcate and annotate spaces.

If I want to add a note to a place, I don't have to physically mark it, I can write a note, add the geographical coordinates of where I

want it left, add the note to a database on the internet and when someone else comes to the place where I left the note their device tells them my note is there and allows them to read it.

No physical note exists but there is a note at that point in space.

Retinal displays that fire a low powered laser directly onto the retina and are small enough to clip onto a pair of sunglasses will allow graphical objects to be associated with places (burning skulls for bad restaurants, spinning tetrahedrons..).

..a landscape augmented with a layer of invisible marking, annotation and symbolism.

symbolism and utility spectrum

Because space is shared and owned, there tends to be a bias towards utilitarian (street signs etc), owner orientated and commercial imagery. Tagging, other forms of graffiti and murals mostly fall outside these categories and get suppressed. Location aware devices would allow subjective and selectively viewable augmentation of environments and give people the freedom to mark, demarcate and annotate spaces based on criteria beyond those dictated by commercial, utilitarian and owner orientated interests.

Utility arguments have led recently to the marginalisation even of architects; with engineers arguing (usually on economic grounds) that structures can be built (by them) purely following principles of utility.

Human beings don't use the buildings they live and work in just to symbolically demarcate spaces, they are used to get out of the rain, or to regulate temperature.

If meaning shifts from the structures themselves to devices, it still leaves a lot of structures...

A fraction of the infrastructure and buildings in human environments are primarily symbolic, but given that most buildings do encode a lot of information beyond their utility, it represents a real shift to have what they encode fall into the hands of individuals and communities.

utopian, dystopian, inevitable

In the UK there used to be just 3 TV channels, limited sources of popular culture and news..

now with the explosion in content, and the diverse sources of that content, society fragments and the wider community has fewer and fewer persistent common cultural reference points

the number of possible subjective realities multiplies..

So far, in media terms, this has largely been confined to what music you listen to, what films you watch, where you get your news. When you go outside what you see is much the same as what everyone else sees, the same street signs, the same adverts, the same shop fronts..

But what if real space is overlaid with layers of invisible symbolism. What if what you see is determined by what the intersection of your extended community and your interests dictate, as well as

what is really there.

Your view of the space and other people is supplemented by additional subjective annotation and symbolism (electronic equivalents of the information communicated by signs, clothing, physical demarcation, shop fronts).

Social fragmentation extends as the technology reaches in to define the whole experience of the space in subjective terms (a dystopian, utopian, or inevitable outcome depending on your point of view).

There's nothing new about subjective filtering of space and people, but externalising the idea and undermining the apparently fixed nature of the built environment erodes notions of common experience and common reference points.

real life

A lot of people live in a house on a street

They might have a good circle of friends

But they don't know that many people on their street

Parallel to that street are many other streets

They don't know many of the people on the other streets

Further there is very little (that is socially acceptable) that they can do to get to know more of the people on their street or on the other streets.

If they're bored they have no way to find the other bored people, if they need to borrow something they have a very narrow range of people to ask, and they can't ask everybody on all the streets.

If they lose a cat, they have to go around sticking photocopied photos of the cat to trees.

In short their interface to their local community is really bad (even if they have a copy of the local paper).

Maybe they go to the local coffee shop and while they're standing in the queue they notice someone who looks interesting. What are the chances that they are going to say anything?

And that's the place they live.

What about when they're somewhere they don't live

..then the problem is even worse. Even with a benign guide like the lonely planet, they're restricted to reasonably reliable commercial interactions. No way to reach out to the local community except through extreme bravery, alcohol or accident.

Without a lonely planet they're stuck with neon hotel signs and mcdonalds and guesswork.

Cities have scaled up so that more and more people live in them, but the people in them are further apart than ever. Idealised close communities can only be found on TV shows, corporate campuses and in the compounds of religious cults.

Which is not to say that nobody has a life, just that there are big and very real boundaries (walls, doors curtains, streets and

social convention) to making sense of your local environment and extending the life you have ended up with.

Conventional points of contact are very blunt, scary and primitive, notice boards at the gym, ads in the local paper, getting drunk, dating agencies, going to martial arts or meditation classes.. (the internet counterparts of these are just as scary, if not more so).

Solving the interface problem would mean making space more immediately familiar and usable and introducing people who wanted to be introduced.

new ways to relate to each other and leverage and extend the possibilities for local community

Leveraging the latent potential from parallel rows of silent houses:

- a playground control system (for making better use of the square of tarmac that is the playground)
- spontaneous help/disorder system (amish collective house building, pushing broken cars, organising riots).
- a boredom finding and resolving system
- coordinating laundry

hitch hiking is practically dead but there are more cars going where you want to go than ever

there are millions of spare rooms and empty houses and millions of people who wouldn't mind you spending the night if they had reason to trust you and you were interesting, or you could pay them, or you had something to exchange

..you could find yourself driving cars that aren't yours, living in empty houses that aren't yours..

40% of food used is wasted in the US, people don't share

there might be a parking space when you need one, but you can't ask the people who can see it even though you might pay to know what they know

There are opportunities to help and to be helped, to exchange or share, that the bluntness of our current social interfaces exclude.

The proposition is that there is latent potential in the system that cannot be utilised without changing or augmenting the system.

The barrier that stops these kinds of transactions taking place..

..is that there is no efficient way to broadcast a request selectively to a trusted group of people you don't know inside a set geographical radius.

..you could solve this tragedy of the commons through a combination of location aware devices, a trust system and a system that could filter and coordinate need.

Common property (common to small self-defining groups rather

than universally and arbitrarily shared) could work if you could solve the trust problem, the filter problem, the location awareness problem and build an interface.

the wealthy tend to share stuff among themselves (because they trust the other wealthy people).

new ways to formalise the sharing and exchange of non monetised latent value

[In many countries sex is implicitly or explicitly, illegally or legally for sale..]

A sandwich shop is not the only place you can get a sandwich, but a sandwich shop is a specialised source of sandwiches. It's externally marked, and visible and identifiable as a sandwich shop, it's designed to be open and entered by people, and the sandwiches are priced to clarify the nature of the transaction. Convention dictates and supports the efficient transfer of sandwiches from sandwich vendor to customer.

So convention, visibility, efficiency (through specialisation and centralisation), dictate that when you want a sandwich and you aren't near your kitchen, you probably need to find a sandwich shop.

So you need to find a row of shops and then find the shop that sells the sandwiches.

..alternatively you could state what you were seeking (in this case a sandwich) selectively broadcast your request (perhaps to a local subset of a community with which you are aligned), state the range of exchange possibilities you would consider (information, work or money, conversation, things).

The range of responses might include automated directions to the local sandwich shop, or a note telling you to knock on the door of the house across the road (if you would be prepared to take some laundry to the Laundromat in exchange for a sandwich).

Despite there efficiency, shops, money and 20th century convention have a limiting effect: on the range of formal exchanges that are possible, the people who can take part in those exchanges, and where those exchanges can take place.

The problem with barter systems is that they require an incredible level of serendipity, both parties have to have something the other party is prepared to accept if the transaction is to be successful. Which is why cash is such a useful neutral point of exchange. The simultaneous need problem is surmounted by the neutrality of cash.

Physical markets were the traditional way of making the required serendipity more likely to occur.

The ultimate evolutionary outcome was that you would specialise in geese, bring your geese to the geese seller, exchange your geese for some coins and then go and buy some chairs with the coins (and the chair seller would buy some chickens with your coins, converting your coins into chickens).

But life is getting more interesting and if you are able to efficiently extend the range of possible exchanges, exchange locations, and

people to exchange with, then why not?

So you get a sandwich without walking further, at the same time meeting someone from your extended community (the system handling at least the greater part of the trust issue), and make the exchange in terms that might be more favourable to you than handing over money (or perhaps your money circulates within your community rather than outside of it).

You can know what other possibilities exist.

moving From a web model to an externalised identity model

This idea of broadcasting need is part of what has been called the 'pursuit' model. If you have a mobile device, beyond its direct communication function, you probably want it to help solve your immediate problems and to help you fulfil your immediate needs.

To take this idea further you could use some kind of externalised identity that can give a respondent a context for your request (community allegiances for instance), and a formal way for each party to measure the trustworthiness of the other.

Building trust systems, externalising identity, and matching requests to possible respondents are extremely difficult problems. But they are problems that people are working on solving.

Huge numbers of people are walking round with mobile phones, that is, wireless digital devices that already know roughly where they are (and these devices are getting rapidly more capable). Most of these devices are struggling to fit in with the web model when clearly the screens are too small and the tiny keypads inadequate for traditional web surfing.

The web is already in some sense an exchange, a way to get information from one entity or person to another. The problem is to build a more efficient exchange.

The web lacks the concept of identity. You may have an email address, or a phone number, both of which in some sense function as a persistent extension of you, (collecting and facilitating the exchange of messages), but they do not facilitate more sophisticated transactions on your behalf. They differ very little from the function of the mat below your letterbox. You may have a web page, but an individual's (as opposed to a corporate or organisational) webpage is usually a fairly static entity, a symbol, rather than a transaction mediating entity.

The point is that your internet identity is not a coherent, functioning, device independent manifestation of you, it does not formally embody your trustworthiness, it does not formally record your community affiliations, it does not communicate your needs or solicit opportunities to fulfil the needs of others on your behalf.

The web model can work pretty well if you have the time and the skill to find what you want, but the constraints of mobile devices both require, inspire, and offer an opportunity to develop, more efficient, individual-centric, and spatially linked exchanges.

Filtering, reputation, trust systems and infomediaries

the deep irony is that even as people are packed ever more closely together the gap between them widens.

People have spent the last 40 years devoting more and more time sitting in front of computer monitors and tv screens simulating community and ignoring the people living next door and down the street.

blocks of flats, estates, streets of people who only get to realise that they might get along, or be able to help each other, when something goes wrong.

filtering

You can filter who you talk to by speaking in a specific forum,. Leaving a notice on a notice board in a climbing wall means that only climbers get to see the notice. Leaving a note next to all the notes taped to a particular bus shelter near 110th at Broadway nyc near Columbia university means that you narrow down the range of people who see the note.

~ anonymity

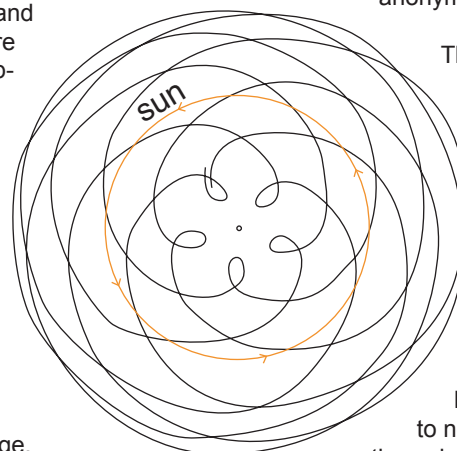

There need to be good grounds for sanctioning meeting people you don't know.

Real life filters include the anonymity conferred by front doors, walls, curtains and cars. Convention dictates that outside of a narrow range of transactions (commercial, educational, crisis...) people for the most part don't talk to people they don't know.

Real life filters tend to be quite blunt tools, but people prefer tend to prefer blunt filters to no filters. The kinds of people who try to break through these filters tend to confirm the need for them.

Filtering is a problem, and it is not confined to local communities but all kinds of communities. Email filtering attempts to remove junk mail. Joining an online discussion group focused on a specific subject is a kind of filtering in itself, but within those groups it is often possible to block out the voices of participants you don't want to hear.

Filtering is a problem aligned to trust. We mostly choose to interact with people we are both interested in and trust not to make our lives harder. A good filtering system with a trust component would make it possible to find more people who fit this criteria, locally or at a distance.

formalising trust

A workable trust system could be built around traditional measures of trust

..friend of a friend, similar views, taste and or buying habits, education, community affiliations, financial status, employer, reputation.

Even with an effective trust system in place, in interpersonal

relationships it still only serves as a guide and lowers the barrier, maybe making a face to face meeting more likely to be worthwhile or safe, it still comes down to the reality of the actual meeting to determine the reality behind those grounds for trust

Trust is a difficult problem” Jan Hauser, Sun microsystems

infomediaries

A system which requires information about you to be broadcast is unlikely to be acceptable.

The solution is a trusted intermediary, a third party that handles filtering without revealing personal details.

There has been a recent explosion in dating agencies, and while they handle a very specific problem, they are a model for mediating between parties without directly revealing personal information.

A community agency built on similar principles but handling a much wider range of interactions would be interesting.

This could be a further iteration on ‘craigs list’ in san francisco which already functions as a kind of community agency, a digital equivalent of a community notice board, tied to the space only indirectly, but still capable of making things happen that would not otherwise happen.

Recently craigs list made the national news after a girl posted a note about a ‘gorgeous guy’ she kept seeing at the bus stop on her way to work. The result was that each morning more and more people turned up at the bus stop to see the ‘gorgeous guy’. The boy, who was increasingly aware of something strange going on, only became aware of the extent of his local celebrity when a friend of his worked out what was going on and told him.

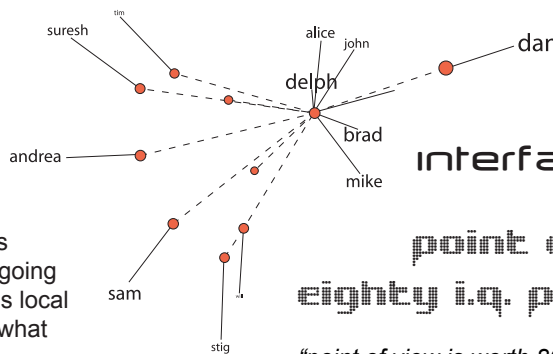

A range of new, sophisticated and interesting, ways of mediating transactions and finding and interacting with people are becoming available, and location awareness adds another dimension to the possibilities.

[random meetings generator]

architects and their machines For living in

Architects and planners have designed buildings, housing projects, and whole communities, and then tightly packing those places with people who don’t know each other, and doing so without being able to build sophisticated interfaces and information systems for those communities.

Cities are arguably so complicated and house so many people that we may actually need technology and augmentation to be effective and happy in them.

The most help that has been offered so far has been video surveillance, a dark form of augmentation, which assumes you can change people by watching them.

A more pragmatic and people friendly approach is a location aware one. In Brighton in the UK and San Francisco in the US bus shelters now tell you when the next bus is coming (because they know where the bus is). This small thing will save souls, there is nothing worse than waiting hours for a bus that may or not ever come, it makes you feel so out of control.

..Corbusier and his machines for living in, Paolo Soleri and his arcologies and Archigram and the walking cities, all look like (and in the case of Corbusier actually are) nightmare scenarios, and the only thing that could make them happier places to live (given that tightly packed ‘modern’ alienated communities have become a reality) would be better interfaces to real and local spaces. This is a troubling thought given that it is dark to propose more technological innovation as a solution to the problems that technological innovation has brought forth.

But if lost old age pensioners on a difficult housing estate could communicate with each other and coordinate their actions and their voice, it might make a difference to them.

With hindsight and foresight it seems inevitable that housing projects couldn’t work without information systems, and those information systems haven’t been built yet.

..and I want to know where my keys are and where I left my wallet, I want to be able to call them and ask them where they are. I want solutions to very ordinary, localised, spatially linked problems.

semantic web interfaces

point of view is worth
eighty i.q. points

“point of view is worth 80 IQ points” Alan Kay

[via blackbeltjones]

concept mapping (tinderbox
view)

[basic introduction]

Say I have 10 different, but loosely associated, thoughts noted on a piece of paper and I open Tinderbox. Hitting return creates a new small rectangular box on the screen, the associated dialogue lets me name the box and then a text window opens where I describe the thought in greater detail. The text box closes and I have a simple named box on the screen (double clicking brings up the longer text description).

I do this for ten different thoughts and end up with ten rectangular boxes spatially arranged on the screen

[image]

I can then start to group and arrange them, cluster some, and separate others, leaving me with whatever spatial arrangement represents the order my intuition suggests. Then having decided on some arrangement and some grouping I can represent that

graphically by colouring groups of boxes differently. I'm free to say what the color means, based on the grouping I've established, maybe priority, maybe similarity, or whatever.

Say three of the boxes (now all made green say by selecting a colour for this sub-group) are places. I select them, open the new attributes dialogue and add a common attribute 'geo'. I decide that this attribute is boolean in character (that is it can be set to true or false) I set the 'geo' attribute for each of the three 'place' boxes to true. then I add two more attributes for this green group: latitude and longitude. Incidentally having defined them once these are now global attributes and I can set geo, latitude and longitude values for any box (most new, and existing, boxes will by default have geo set to false and, not being places, will have neither latitude nor longitude values set or immediately visible.)

So now i have three 'places' and have decided that places are a new class of thing in my document.

Say three more of the boxes reference recent images i've created, I set their colours to blue to differentiate them, since 'images' suggest various properties I open the new attributes dialogue and create relevant attributes. I create a new attribute 'image' (boolean, and set to true), also 'path' - the path to the image file (a string attribute), 'height' and 'width', image file format etc.

Two of these images are schematics, but one is a photo of a place, so I set geo=true on that image and add longitude and latitude. Now should this box be blue or green? Doesn't matter. If I search my document for 'geo=true' it'll turn up and if i search for 'image=true' it'll turn up (and there's also now the new intersecting set of images which are also places which may turn out to be useful).

The remaining four boxes contain specific thoughts and are conceptually related, I decide that one is the central thought and the others are attendant so I drag the three dependant thoughts on to the conceptually central thought box and the main thought turns into a small container with the three dependants inside it. Hierarchy

When I double click the central thought box, this takes me down a level to where there are just the three attendant thoughts. Given these I decide to link two of the boxes to the third, I do this by click and dragging, arbitrarily deciding to name the link type as 'requires' when the link type dialogue box appears, the boxes are now joined with two arrows with the small annotation 'requires' visible above the connecting lines.

I go up a level, double click the central thought box and add more to the text description. I also decide that one of the images is relevant and add an 'include' reference to the one of the image boxes.

Now I have given a shape to what were ten thoughts jotted down linearly on a piece of paper.

And not a cosmetic shape, a structure based on association and categorisation. In the document I have many more pre-existing boxes from earlier work and I can start to link boxes from the rest of the map to the new boxes and maybe move some from elsewhere into the new central thought container.

This map view is just one of many available ordering views on the box entities. As far as there is hierarchy I can choose to view that hierarchy as a tree diagram where all notes are present but notes that are inside other notes are shown indented. There are a

number of other views.

I can also create a box and associate a search query such as 'geo=true' and have aliases of all the relevant boxes appear inside that box. i can also simply open a search window and have all the boxes matching a keyword appear as a temporarily accessible list.

[end basic introduction]

At its heart is a database, which is fine but nothing new. What is different is the level of freedom and intuition that can instantly and flexibly be applied to an arbitrary set of 'things' without starting from a preconceived idea of what they are and where they should go. The rectangular boxes (the basic thought unit) can be anything I need to organise, or think about.

I start with boxes, cluster them, colour them, add attributes. I develop objects based on common sets of attributes, and allow real order to emerge rather than deciding on a data structure and trying to fit my thoughts into it. It's not that all of this is not possible with MYSQL, python and a piece of paper, but the extent to which I don't have to think about MYSQL, python (or the edges of the piece of paper) at the point at which i'm defining my knowledge representation, means that the knowledge can get on with deciding how it wants to be represented.

In fact once you have your spatial map, your attributes, your hierarchy (and changed them all around a few times, continually tweaking all the way), you can output your data as an xml file and feed it straight into MYSQL or whatever.

Alternatively you can create templates and output straight to html, rdf, rss (place feeds, image feeds, thought feeds) or just plain text.

At this point you can also simplify your knowledge representation, for example outputting a complex structure as a linear timeline listing only your latest 'thought' notes (ignoring 'place' and 'image' objects except where they are included within 'thought' notes, or where thought notes have 'geo' attributes). Maybe only output orange thought notes. The resulting .blog is a watered down digestable feed derived from a more complex structure (you can of course output the complex structure as well - no rules).

So it lets your thoughts decide how they fit together using user defined spatial maps, links, attributes and hierarchy. All flexible. You end up with a knowledge representation that helps you both to organise further thoughts and derive further thoughts.

The level of freedom may not make everyone comfortable. Having to continually define attributes and hierarchy and remember where you are in mass of densely connected multilayered mess of boxes might not be for everyone [...it's great]. The level of constraint may offend some programmers who want to hack together something very specific and outside the shapes tinderbox allows. But for people somewhere between those extremes it's more than useful.

There are some issues (take it as you find it, it pretty much works as promised and for something so useful that is no small achievement), but it's obviously been around a long time and been worked on by some very bright people (and people who think about interfaces). The documentation is minimal but intuition and persistence usually get you where you want to go.

In fact tools like this (and there are a few, although Tinderbox is the one I'm working with, Ideagraph being more PC focused) are the missing link as far as ordinary users are concerned. Browsers,

filemanagers, email and newsreaders, all of them fail to impose any useful order on the material they continually stockpile. The basic unit of the internet from a general user point of view looks like being the paragraph of text, whether email, blog entry, section of an IM/IRC exchange or whatever. Tools like Tinderbox can break through the stranglehold of timelines, alphabetical indexing and a few inflexible categories, that for many users are starting to feel like bleak living arrangements. It is still the case that most of the tools that offer you flexible control of your metadata are 'roll your own', or enterprise level, at least at the moment.

simply put

file system <-> personal knowledge representation <-> browser
<-> aggregators and peers

the first two should be integrated maybe?

Tinderbox and Ideagraph may well be what mosaic for the semantic web looks like.

On the Tinderbox site and elsewhere it's been called a 'personal content manager' which is kind of OK, but I think it overstates the outward cosmetic view. Multiple and flexible presentation output forms are an easy byproduct of the data knowledge representation possible using tinderbox, but the visual, spatial, intuitive, conceptual model is much more valuable, its a place to think. In terms of thinking tools it's the difference between making a model that looks like an aeroplane and one that flies like an aeroplane. Tinderbox being in the latter category.

Recently headmap produced a movabletype plugin, reached the point where it needed two extra fields: longitude and latitude, and found that short of getting users to hack the Perl (which didn't feel like an option) it wasn't possible (at the time) [In defense one of the reasons for the success of blogging tools is the simplicity of the interface]. It wouldn't be so hard to create a specialised authoring tool for 'place' feeds or to find a blogging tool that allowed extra fields. But really the problem is not just adding extra fields, its more general, how can ordinary users work with open frameworks like RDF without flexible agnostic authoring tools. Tinderbox is such a tool, RDF no problem as long as you create the right set of attributes and build a template, the output can be anything and is very much a side effect (its form agnostic).

It allows the building, authoring, and organising of knowledge representations (not arcane databases accessible through the slit of minimal web form or regular expressions at the command line, not collections of oddly named text files or an endless spreadsheet grid, and not a \$6 million custom built enterprise specific solution).

Referencing the example above, having set the 'geo' attribute and added 'longitude' and 'latitude', those values are accessible when you export. The export template for an RDF place feed for one of the green 'geo' notes above might include:

```
^get(geolat)^ ^get(geolong)^
```

which in the final feed resolves the tinderbox attributes to

25.28

81.54

..a great tool for ontological anarchists

interfaces to the semantic web

Ted Nelson, who was the first to see the potential of hypertext had as his data ideal layers of acetate representing user annotations of an original document - you choose the layers you want to see.

Apparently Google's initial goal was to develop a web annotation layer.

Personal data is increasingly structured and parcelled up (XML), parcels of marked up data are given unique addresses (a URL), then metadata about and relationships between URL's (and more generally URI's) can be stored anywhere with URI's, XML and RDF tags acting as keys asserting the links and relationships between the seperated data.

This allows for a personal XML feed representing personal annotation applicable to various user defined URLs (the original document [URL] may contain author annotation, and allow direct reader annotation - so such seperations are arbitrary - but thinking about personal annotation feeds and documents seperately helps in thinking about this stuff).

Moreover using RDF it is possible for a machine (or a person) to succinctly deduce the *meaning* of the link a person (or machine) perceives between URI's - and further those connections are expressed in terms of a shared and agreed and extensible vocabulary (RDF)

i.e. not just conventional links and metadata but traversible Triples:

Sam [subject - URI = sam's email] --> KNOWS [connective (from shared RDF vocabulary e.g. FOAF)] --> Anna [object - URI - anna's email]

That is a machine and human comprehensible relationship formally asserted between two URI's using defined ontologies and vocabularies.

On the interface level structured data makes for a positive feedback loop. Which is what has been experienced with blogs. A bit of structure has led to blogdex, technorati, trackback, feedster etc. Adding explicit machine readable meaning to links offers similar possibilities.

exposing and structuring data and clearly defining relationships in a distributed environment offers a vision of a new kind of interface.

Something that looks more like Danny Ayers Ideagraph or Mark Bernstein's Tinderbox .

These tools allow you to create a personal and sophisticated annotation layer to data both local and external, and also to expose your annotation layer as an XML feed. They are very visual tools. More tangibly like maps and graphs than conventional PIM's like Outlook.

A new object is depicted as a coloured rectangle, it can refer to itself or a file elsewhere, you name it, you can open it and edit it, adding text and images. Close it again and connect it to other boxes using RDF or your own vocabulary to define the nature of the links. Your main view is boxes arranged in front of you with arrows (carrying link annotation) connecting them.

These kind of tools allow for grouping of all kinds, by color, creation date, parent child, and hierachical relationships, link attributes, keywords - all allowing you to rapidly define different views on your data, both in terms of search criteria and in terms of the visual apperence of your map view (treemaps, outlines, charts).

From the point of view of the graph based front end note also the Plumb Design Thinkmap application Visual Thesaurus , and all the Touchgraph applications, these graphical views on data are starting to look like genuinely viable models for future desktop (and wearable) interfaces. Intensely structured logically linked data lends itself to this kind of visualisation.

Just using these tools results in smaller chunks of data, more structure, more link attributes, more metadata and more URI annotation (in the same way traditional blogging tools enforced structure and added metadata).

Given connections and nesting and a range of attributes to choose your focus attribute from, these models are highly navigable, and in an open context start to realise some of the promise of mindmapping and mindmap sharing.

More than personal content management tools they give the power to define relationships between things to the only intelligent agents on the net: people (intelligent tools + people = intelligent agents)

After a decade of hugely expensive visual, graph based, business management tools focused on exposing arcane databases as simple objects that can be linked according a vocabulary in tune with business logic, for business leaders to apply their intuition to (without having to send requests to the IT department), some of that power is trickling down into the hands of ordinary internet users.

Create a simple graphical representation of a local file with a URI linking the representation to the original file on your computer. Add attributes and metadata to the representation and then link the representation to other representations of other files both local and external, and logically define the links. Share parts of this map and have the ability to expose local files within the shared parts of your maps. Further these representations can become more complex [defining methods and attributes] defining the terms of interaction and function of what they represent. Drop, or link, a simple file representation on, or to, a function representation and generate new entities, or change the nature of existing ones, or maybe add representations of particular types together.

..and these ideas are rapidly headed towards the ordinary user: from the Semantic Web, open and closed source interface projects like Ideagraph and Tinderbox to Microsoft's Longhorn and Mitch Kapor's Chandler.

these developments address..

the connections between things, the nature of the connections between things and seeing the connections between things.

These connections are now viewed as valuable enough to be considered seperately from the the things they connect.

..you can choose to expose as much or as little of your personal map as you like.

..you can traverse these maps to find information relevant to a given search criteria, or if you like someones point of view, just follow where they and their map leads you.

the paragraph of text

..have a lot invested in skywriting

been thinking about the paragraph of text as the sort of 'golden section' of internet communication

how blogs and email assume the same basic form, roughly a paragraph of text

and how they both (one sometimes seemingly, the other actually) resemble a part of an ongoing conversation

SMS users struggle with great ingenuity to get text messages full enough of meaning to reach the email/ blog paragraph level of useful meaning.

Telephone conversations are useful but email and blog entries have the advantage of being written down and we can do a lot more at the moment with stuff thats written down than recorded voices.

blogs, email, usenet, news feeds, text messaging.



. just paragraphs, metadata and a database on a network

these thoughts stem from the idea of annotating space, there will be visual ways to annotate space, but a paragraph of text would go a long way towards starting a conversation about a place.

back to the oral tradition through skywriting

"What was the adaptive advantage of language? It can only be measured in relation to the competition. Those who cannot acquire knowledge by hearsay must do it the hard way: by direct, trial-and-error sensorimotor experience.

.. In an evolutionary competition, the symbolic "thieves" quickly out-survive and out-reproduce the honest sensorimotor "toilers," who must learn everything the hard way, from experience.

.. language is a form of reciprocal altruism: Except if we are competing for the same finite resource, you lose nothing if you tell me, honestly, what is and is not edible, or which are and are not dangerous predators; and tomorrow it may be I who know something that you do not. So "cognitive barter " may be a better descriptor than "theft " for the adaptive advantage conferred by language.

.. Dialogue not only informs, and trades existing information; it also elicits and stimulates novel interdigitating thoughts that again may not have occurred solo. In that sense, interactive cognition may create information.

.. Surely it is writing that made science and scholarship if

not possible, then at least far more likely ... But writing also had a dramatic negative effect ... on the temporal, interactive dimension of linguistic discourse. It instantly transformed it into asynchronous, off-line monologues instead of the synchronous dialogues for which our brains and our thinking capacity are optimized.

.. One of the limiting factors in oral monologues is memory: If, in a conversation, you speak for too long without letting me reply, I will surely forget some of what you said, and my eventual reply is bound to be much less focussed than it could have been if the chunks between interventions had been smaller."

Extract (with gaps) from

Back to the Oral Tradition Through Skywriting at the Speed of Thought by Stevan Harnad

gysin, burroughs, cut ups and knowledge management

gysin, burroughs, cut-ups and knowledge management

..thinking about location awareness in terms of cutting together different subjective viewpoints

..and also about knowledge management tools.

The conscious mind seems to be one strata of a larger internal awareness.

The conscious mind has many ways to communicate with and access this larger awareness.

..and one way is through cut-up texts

The cut-up techniques of Brion Gysin and William Burroughs aimed to actively liberate meaning from texts and to bypass the tyranny of conscious attempts at organisation of ideas.

Gysin suggests taking texts that have meaning for you and some that don't, cut them together and find what you are looking for (or at least something new) in your interpretation of what results from the cutup

..a good addition to a knowledge management tool would be one of the many cut-up engines on the net

There are a number of software cut-up engines, all you have to do is cut and paste one or more texts into them and hit the 'cutup' button

the ancient art of memory and architectonics

The Ancient Art of Memory and Architectonics

4.1.1. The Ancient Art of Memory and Architectonics

The ancient Art of Memory was a highly prized and praised skill as Frances Yates has shown (YATES66). It is of no coincidence that the ancients used architectonic models for their artificial memory technology.

[.]

It was for this reason, that everyone learning to apply the Art of Memory did so perambulating the halls and staircases of the temples and monuments. In these perambulations, the candidates learned unconsciously the intricate connections that had been incorporated into the construction of these buildings.

from

INFRASTRUCTURES OF REPRESENTATION: A QUEST FOR MULTIMEDIAL SYMBOLIZATION SYSTEMS

by Andreas Goppold

thanks to Rich Persaud for sending headmap off to read AG

[EXTENDED QUOTE FOLLOWS]

4.1. The tradition of the Ars memoriae

Art of Memory, Raimundus Lullus, Giulio Camillo, Giordano Bruno, Leibniz: Characteristica Universalis, Aby Warburg.

The issue of memory is a focus point in the discussion.

We must not be confused by contemporary mis-uses of the word memory for technological storage devices as they appear in computers: e.g. Random Access Memory RAM. Human memory is still an entirely different matter. This is just a good example how we can be totally misled by wrong terminology.

4.1.1. The Ancient Art of Memory and Architectonics

The ancient Art of Memory was a highly prized and praised skill as Frances Yates has shown (YATES66). It is of no coincidence that the ancients used architectonic models for their artificial memory technology.

[.]

It was for this reason, that everyone learning to apply the Art of Memory did so perambulating the halls and staircases of the temples and monuments. In these perambulations, the candidates learned unconsciously the intricate connections that had been incorporated into the construction of these buildings.

[.]

These ratios could be experienced fully by the kinesthetic sense and much better than through alphabetically framed analytical and mental exercises as has become the norm in our linear-text based age.

Anything experienced and walked-through physically, with the kinesthetic sense, becomes an engram. It is memory matter that will not decay for life. (Everyone who has learned to ride a bicycle will attest to this. Totally unlike anything one has learned analytically and mentally only. This was, and still is, the secret of the Ancient Art of Memory. Since the alphabetically framed mind will be reluctant to even consider such an option, there is a good chance that it will be lost forever, even though it is mentioned here. It is hard to penetrate the fortified walls of 3000 years alphabetikolobos.

4.1.2. The peripatetic school and the implantable Walkstation

Perhaps it is not just a coincidence that the school of Aristoteles was called the peripatetic school (=perambulate). Because even though he never mentions the principle, Aristoteles was a quite acute observer, and the fact that all the orators and lawyers composed their speeches perambulating in the halls and staircases of the temples and public buildings, might not have escaped him. Even without the more esoteric principles of cosmic harmony, it is undoubtedly a definite factor that helps learning, and thinking, when you keep the body in motion, breathe some fresh air, and see some beautiful vistas.

The public building programmes, starting with Perikles, had seen to it, that this place was one of the most breath-taking and stunning visual experiences that any place on the globe could provide. So, even if he doesn't mention it in his philosophy, Aristoteles might have known what he did, and why he did it.

[.]

Of course, a little technology that helps us do our word processing while walking might come in handy. If we have a Walkman, we can also afford a Walky-Symbolator. We are technically not too far away from the implantable Workstation, which we then call a Walkstation.

the connections between things more interesting than the individual things

Doesn't it seem like the action in personal publishing has moved away from weblogs... and towards the interaction between weblogs? The blogosphere has become a living breathing entity, capable of behaviour that's increasingly difficult to predict.

Which of course, brings us back to my latest obsession: Ants. As Mitchel Resnick puts it, there's a similar relationship between ants and their colony (emphasis added)

Why the growing interest in ants? Many people, it seems, are intrigued with the collective nature of ant behaviour. Each individual ant is quite simple. But an ant colony as a whole is capable of rather sophisticated behaviour.

This is exactly what I mean! Extending the metaphor a bit:

PCs : Networks :: weblogs : blogosphere :: ants : colony

I definitely wouldn't say that 'each individual blogger is quite simple'. But there's definitely some extremely sophisticated behaviour emerging out of the interaction between bloggers.

[..also evidence of unsophisticated behaviour]

from microcontent news 22.12.02

context aware applications

The following is an example of a complete stick-e note:

(1,4)..(3,5)

150..210

December

The large floodlit building

at the bottom of the hill

is the cathedral.

[The above note would be triggered if the user was within the specified area, facing South in December.]

[...]

PARCTab applications created at Xerox PARC were concerned with presenting information. These included:

- presenting information about the room the user was in, e.g. when in the library they could be presented with information about the library. This information could either pop up automatically, or could be under the user's control (e.g. there could be a This-room button in the menu which, when selected by the user, gave information about the current room).

- helping the user find the most convenient local resource, e.g. the nearest printer. The PARCTab can present a menu showing all the available printers, and the distance of each from the user's current room.

- attaching a certain UNIX directory to a room; when any user enters the room all the files in the directory are shown. The directory is writeable by everybody, so anyone can post a note in a room by creating a file within its directory (in an office: "Back in 5 minutes", "Remember to turn the equipment off if you are the last to leave").

[...]

Authorship [of stick-e notes]

how an author sets about creating a set of notes.

The approach to authorship follows the simple Post-it note metaphor:

(1) You write a note on your PDA screen, using a keyboard, stylus or whatever other means is offered. As an example you might be on the outward leg of a hike, and your note, written on a PDA with a location sensor attached, says "Turned left here, by the pond".

(2) This is automatically stored as the body of a stick-e note, with the present context attached as its context. Thus if you are at a certain location, this is the context for the new note.

(3) Whenever you return to the same context, the note is triggered. Therefore, on the return leg of your walk you will be alerted to the point where you turned left on the way out.

At the end of the walk you might wish to save all the notes you made; these would form a stick-e document. You might give the document to a friend or even publish it on the web after you had refined it a bit.

The above approach applies equally well to our animal example. Here the context will be in the presence of a certain animal rather than at a location. We will take this to be the animal most recently detected by the sensor.

[...]

Stick-e notes are, perhaps, half way between a program and a document: certainly the contexts have to be as accurately specified as a program. There is little doubt that maintenance questions will be the limiting factor on how many notes it is viable to handle: would a tourist application of 10,000 notes be tractable? We have tried to anticipate the potential maintenance problems by adding features associated with programming languages: these include the use of types, declarations and testing facilities.

Context-aware Applications: from the Laboratory to the Marketplace - Peter J. Brown, John D. Bovey and Xian Chen

augmented capitalism

Freedom ants

With the geo enabled foaf adhoc mesh internet in your pocket you should be able to turn a big piece of cheese into a hat no problem

broadcast your cheese, your location, and your need for a hat

..maybe money will come into the equation maybe not

..maybe you'll get a free hat and give away your cheese

..maybe you'll meet some friends of friends

the internet is a collaboration, exchange and transformation mechanism soon to have more cool features than money

the declaration of interdependence

WE HOLD THESE TRUTHS TO BE SELF EVIDENT (UNDER THE PRESENT CIRCUMSTANCES).

ABSTRACT

The internet is a form of currency with more cool features than cash.

Thingster

The internet is a transport mechanism. A way of transferring information from one place to another.

As a transport system it is well suited to facilitating exchange.

It's an economy engine, rather than an economic engine. It hosts markets.

Link economies, file sharing economies and one particular world wide garage sale.

It can bring a whole complex market infrastructure to any given physical transaction

rather than looking for cash replacements, for some mythical ecash, consider the internet itself as the exchange facilitating mechanism.

Lists

Napster was about everyone making a list (computer generated list of your mp3's), aggregating all the lists and then allowing people to search the final indexed Uberlist for a fast match (local being a metaphor for fast).

Blogging is about a list of discrete diary entries each containing the currency of the blog world: identity, thoughts and links.

Again the lists are aggregated, you can search for thoughts, and blogs get ranked according to how many inbound links they accumulate and how fresh they are.

Like napster you can see what else a user has, if you happen across something you like from that user. You just use an RSS newsreader to subscribe to that bloggers changing list of thoughts.

Its about structured aggregated lists...

Geourl

Now there's GEOURL

geourl means that bloggers can specify the geographical location of there blogs in a general and machine readable and more specifically an aggregator/search friendly way. headmap has focused on the idea of overlaying the internet on to the real world and the real space, and this line of thought extends to..

CONNECTING THESE NEW AGGRESSIVE COMPETITIVE DISTRIBUTED, AD HOC, 'WEIGHTLESS' ECONOMIES TO THE WORLD OF REAL THINGS.

Back to ebay

..all of which leads back to Ebay

"the market may be bottom up but its populated by chronically top heavy agents" Steven johnson, Emergence

maybe you have a lot of stuff, and some of it you'd be prepared to exchange or sell. You could use a service like Ebay, but they charge you for the privilege of selling your stuff, you have to go to them and you have keep an eye on their site.

Why not just make a list of your stuff and put it somewhere so that potential buyers can come to you..

Aren't there tools for that now?

Couldn't you make a tool to allow the creation of structured lists of real physical stuff and create a specialised list aggregator for this? Put GEOURL tags in the individual lists and have the aggregator index the lists by location, category and freshness for ordinary people to search for stuff in their area.

And this is the bare minimum..

..couldn't you create external modules to plug into this open system? Reputation modules, privacy modules, maybe FOAF (friend of a friend) networks for distributing lists among your friends rather than just to everyone.

Wouldn't this create a more generalised open and competitive market than Ebay?

And why stop there?

Exchange Criteria

Extending the principle you could also add a list of the stuff you NEED. Then the aggregator can start automatically matching needs to wants and buyers to sellers; connecting the right people in the right location. And this kind of market could sustain more complex exchange criteria than cash. In fact it could support ALL KINDS OF EXCHANGE CRITERIA

If two people want what the other has this system can hook them up. They can then decide the basis for the exchange.

One alternative criteria would be barter. Barter could work. If time, location and needs and wants are all in the system, needs can be matched up to wants.

This doesn't have to be a simple two person match. If Joe needs what Tom has and Tom needs what Sam has and Sam needs what Joe has, and they all live locally, the system can hook them up.

Mobile Computing

None of this takes into account the mobile computing revolution that's under way. Decentralised mesh networks. Take the center out of the system.

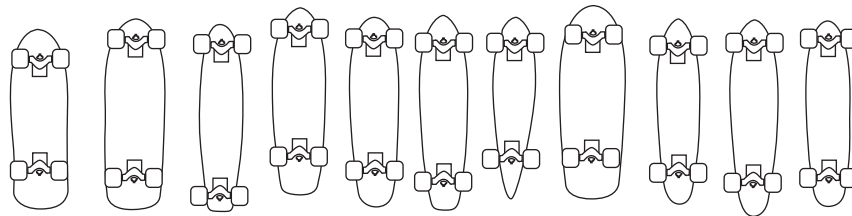

Hedges not walls.

Initially such a system could be linked to blogs. The reputation of buyer and seller can be assessed in terms of the bloggers reputation.

You need a lift? State your destination, your peer group and your friend network and start walking. A car pulls up you get in and she drives you where you need to go. Didn't cost anything. There's room for a gift economy and trust modules here. So maybe barter has been forced so far into the subconscious of western society that it's going to be hard to bring to the surface.

People still remember libraries though...

Books

Perhaps initially restrict the systems exchange space to books.

Josh Schachter of GEOURL suggests: consider a 'like for like' exchange of just and only books. You make a list of books you have and books you need. Books have a namespace (ISBN) which is useful. And books have an abnormally large spread; that is you tend not to be able to sell a book for anything like what you paid for it despite its continued value to someone else who wants the book. So if you can exchange a book you no longer need you're saving money and recirculating something which previously wasn't cost effective to get rid of. Also if someone has a book you want and you have a book they want, you might have something in common.

The consequences of such a system working could be far reaching.

Just taking the final limited book example: this is a worldwide interconnected and distributed library.

If the system were generalised it could become a payment mechanism. A real supplement to cash. Your exchange list could include services (things you can do for others) as well as things, so that you could refer people to your list as means to get what you need. The internet is facilitating a wider range of exchange possibilities and market permutations, and by extension real life cooperation and collaboration.

Commercial Opportunities

None of this excludes traditional business opportunities. In fact an open system would create considerable opportunities and competition. An intermediary could handle the transaction much as ebay does, maintaining a reputation database that determines the level of risk involved with dealing with a particular seller and taking a cut of the transaction. But fundamentally this system leaves the choice up to the user, whether to negotiate directly or engage a third party to handle the transaction.

Identity and Reputation

More interestingly it reinforces the right model for the future of the internet. The identity and reputation component, and the links between things are the only part behind walls everything else is distributed and open (even when it's secured).

and community or social links implied by a system like FOAF (friend of a friend).

Exporting successful internet models to physical reality

Our collective distributed abstract exchange mechanisms are resulting in exponential (abstract) gains

physical exchange along the same lines will behave differently. But without a new model for physical interdependence how are we going to sustain these abstract models?

looking at the fascinating, aggressive and competitive collective distributed internet models - open source, napster, blogs..

We can stretch the models of cooperation, collaboration and decentralisation and above all collective interdependence

to include world of real physical things

"Decentralised production and development have done wonders for the world of open source software, where certain fundamental rights of ownership have been disavowed, but it remains a real question whether the more proprietary wing of late capitalism can model its internal organisation after ant farms or neural nets." Steven Johnson, Emergence.

But this is about augmenting capitalism not replacing it. Its not

a Let system its instant localised market making. Cash is very efficient and will persist, but perhaps alongside a raft of other exchange mechanisms (including Let systems)

[..and doing all this is not that hard all of a sudden]

Napster and Ebay

..at its height napster may have had somewhere in the region of 50 million users.

..an estimated 30 million people were using Ebay in 2001

Ebay was one of the first internet stocks to be excessively over-valued. It is also one of the few internet companies that has been consistently profitable

When Ebay emerged as a phenomenon, people questioned its value. There was an argument in Ebay's favour that went something like this: Ebay is a model for how all business will be conducted in future. When questioned, the woman running the company stated that Ebay was just a big garage sale.

Trade on Ebay doesn't show up in the GDP. But it is having an impact on the economy.

Manufacturers have reported dramatic falls in returned good. People just sell the stuff they used to take back on Ebay.

And Ebay is efficient for both buyers and sellers. There's a story about a woman who was selling a broken printer on Ebay, in the end someone bid \$50 dollars for it and went round to pick it up. When he arrived she said to him 'it's not worth \$50, i can't take the money from you', he replied 'it is to me' left the money on the table and took the printer home.

Ebay in many ways is an old school DotCom. You enter Ebay's world, you play by Ebay's rules. Even though it looks like a decentralised market the center holds, the buyer is seperated from the seller even as they are brought together. Ebay is not peer to peer. Ebay is not like gutella or kazzaa.

What components are most valuable?: maybe the central idea, the cash in the bank, the brand, the reputation system, the ability to mitigate risk and preserve the privacy of both the buyer and the seller, the payment system.

Internet Evolution

The last six months have seen a new embryonic internet emerge into the light.

This new internet is more decentralised, structured, logically interconnected, people centred, and increasingly location aware

..maybe you have a newsreader that goes and gets rss feeds to save you trawling your favourite sites, maybe you have a blog which kicks out a structured rss feed and pings a blog search and analysis engine. Maybe you use one of the new selective blog search engines like feedster or blog link analysis engines like blogdex and technorati, or even a blog extended family tracker like blogstreet. Maybe you see the patterns emerging at a higher level. Blogs are now less interesting than the relations between them. Blogs are things to be aggregated, searched for patterns, ranked, indexed, analysed, those results being valuable to ordinary users as much as academics. What are bloggers tripping out on right now? Check blogdex. Feedster has a lag of about an

hour, Google sometimes as much as a month. These tools are selective and they can become more so, answer questions like: what is this extended family of bloggers tripping out about, what are my friends tripping out about?

All these new capabilities are emerging through distributed collective tweaking.

scarcity and greed

scarcity is an activating force, and so is greed.

dynamic systems need activating forces

The internet puts all the people interested in a given thing effectively in the same room.

this means (in many cases) that anything any of them have ever wanted to do in that area of interest just got easier.

real possibility and real opportunity are activating forces

capitalism hasnt Failed

augmenting money

capitalism hasn't failed, but its hardly succeeded either

it needs augmenting

equity

shares

patents

percentages

copyright

buyer remorse

the corporate shilling

[...]

corporate [institutional] memory

[new idea]

products

Recent legislation makes companies responsible for the entire lifecycle of their products; up to and including recovery, recycling and disposal. Making products disposable will get expensive. The result may be an extended relationship between the company, the customer and the product out in the world. You don't buy or lease the appliance (which no longer has planned obsolescence built in) you lease 'a washing capability', which the company maintains.

house shops

In the 1920's in the UK a new phenomenon known as 'house shops' became prevalent. People would build a counter in their front room, open the front door and turn their houses into shops.

community transactions

sharing

messaging

note leaving

marking

demarcating

tracking

logging

opinions

trading

constructive collaboration

bartered collaboration

gaming

object orientated retailing

Object orientated retailing means that the thing itself (tin of beans or whatever) has an abstracted identity and mediates information and transactions relating to itself.

right now there are a finite number of digital watches

You go out into the real world to buy a digital watch and you imagine all the different kinds of watches they must have; every conceivable variation of features ought to be available. But only a small subset of those imagined watches are actually in existence and an even smaller subset are in stock at the shop you end up at.

value

Economics is at least in part a function of the way the space is perceived and organised and vice versa.

Money is software.

there are higher forms of wealth.

mediaglyphics

rabid change in the techno economic subsystem

"the realities were money, prices, capital, shares: the environment itself, like most of human existence, was treated as an abstraction. Air and sunlight, because of their deplorable lack of value in exchange, had no reality at all."

"the new style, as it diffuses, is bound to cause rabid change in the techno-economic subsystem. However this system coexists with the other main subsystem within capitalism, the socio-institutional framework. If the latter is mismatched to the former, problems ensue."

Andrew Tylecote

Free stuff

"However even those that have the technology to use a digital document on a primitive personal computer also have the power to reproduce and redistribute the document at virtually no cost. For this reason, publishers have had little interest in distributing articles in electronic form. Instead, publishers have focused on electronic publishing as an enhancement of bibliographic indexes. Copyright has encouraged the growth of libraries as an institutionalized system for allowing individuals the privilege of trading cost against convenience, of reading or borrowing rather than buying. In effect, this means that those who acquire and collect books and journals subsidize those who merely read them. Digital, networked information changes this, presenting a seductive vision of a library without walls but eroding the paradigms of print publishing at a very basic level. As network and storage resources grow in abundance, decline in cost, and are used for an increasing variety of purposes, the medium itself becomes increasingly non-specific, abstract, and trivial. [29] The distinction between the medium (the book) and the content (information) disappears with the dematerialization of the medium and disembodiment of information."

[lost the reference]

micropayments

Without micropayments, the internet is deficient

- micro payments [e.g. pay \$ 0.001 to view a web page which subsequently gets hit a million times]

- smart money [e.g. money that knows where it is and remembers where it's been]

- conditional currencies [e.g. beer money, money that only allows itself to be spent on beer]

..he described how methods employing genetic algorithms are now used to analyse and generate credit scores for potential and existing credit card customers, and that these scores are no longer linked to simple, explicit and explainable rules, so that if a customer is refused credit and contests a ruling, the credit card company cannot tell them exactly why they were refused or tell them what change in their behaviour would result in a favourable ruling. All the credit card company knows is that the genetic algorithms [effectively a black box] generate better returns than the

traditional methods, so that they can't go back to the old methods without becoming uncompetitive.

[physicists who have been recruited en masse by merchant banks have gone some way towards beginning to think in terms of a physics of finance, modelling financial systems in the way they have been modelling natural systems, allowing them to carry on being called physicists and think in terms of physics and get paid]

auCTIONS

Ebay seems a little bewildering, but they were considered by market analysts to be a potential model for future commerce on a more general level.

Anything that can be traded can be traded in an auction context. Internet auction houses as general purpose trading engines, applicable to personalised mass market retailing and business to business, as well as analogous to classified ads.

They allow variable pricing, what was expensive at 6pm can be cheap at 7pm

[supermarkets no longer mark the prices directly onto products]

A modified location aware ebay could introduce a 21st century form of bartering.

markets and Funding

"Beside the few ingots of precious metal we have refined, the mountains of slag are enormous." [internet stocks]

equity lords

Socially disengaged meritocratic elites.

venture hippy nazis

money as a universal solvent

endless capacity for fear in advance

viscera

"In Rome dignity shortens life with more certainty than disease."

"he thinks he's the last coca cola in the desert" Mambo Kings]

olmecs

"And if the emissaries of an advanced civilisation indeed visited Earth, they would hardly have wasted their time teaching the Olmecs to move huge blocks of stone in order to make them into giant heads. The efforts of their human proteges would have been bent to socially useful tasks. Taxpayers from a super-developed planet would have been roused to extremes of rage when they tuned their television sets to Earth and saw their highly paid astronauts busy showing the Egyptians how to make useless pyramids instead of schools and hospitals."

Nigel Davies and his new world stories

new carburetor

new carburetor

If General Motors invent a new carburetor, they can't just recall all the GM cars in circulation and swap out the old carburetor. They can't post a new carburetor to all their customers and suggest they fit it themselves.

If someone invents a new way of using the internet, they can post the code they have written and in a matter of days that new code could be running on millions of machines all over the world.

you can experiment with whole new ways of doing things.

You can test things on the internet.

You can change things just to see what happens.

When someone builds a building, the time from the idea to completion is long, people are used to the built environment being a source of stability and inertia.

..using location aware devices, it becomes possible to alter the built environment instantly

misunderstood technology

Redefining space.

Refining community, conflict, movement through space and control of space in terms of new technologies.

The Germans decided to see the space very differently prior to WWII. In tanks and planes that hadn't existed a few years earlier, they drove round and flew over static defences. They used radio communications and speed of movement in a way that those they attacked could not respond to. They spoke a new machine language.

Military theorists are struggling to assimilate the implications of new technology for future conflict.

Networked culture has yet to articulate itself clearly in spatial terms.

The real change happens when networked communities and data manifest in spatial terms.

Network culture is already colonising without being noticed.

..the nineties resemble the twenties

In this regard, the 1990s resemble the 1920s - the period after World War I - a time of major technological changes - with improvements in tanks, planes, and electronic warfare - leading to new doctrines that would optimize their use (e.g., blitzkrieg)

[...]

[those who] thought through the conceptual problems of the day

- achieved striking successes in the opening phases of World War II

the Germans, who, in their victory in the Battle of France in 1940, achieved success in four weeks on the same ground where victory had eluded them for four years during the previous war.

The implications of a revolutionary technology are often not widely perceived at first.

People try to fit the new technology into established ways of doing things; it is expected to prove itself in terms of existing standards of efficiency and effectiveness. It may take time to realize that inserting the new technology into old ways may create some new inefficiencies, even as some activities become more efficient. It may take still more time to realize that the activity itself - in both its operational and organizational dimensions - should be restructured, even transformed, in order to realize the full potential of the technology.

[period of adaptation]

[...] it augurs transformations in how societies are organized.

[...] a new epoch of conflict.

from John Arquilla, David Ronfeldt, and Michele Zanini - see netwar and zapatista note for full text source

interfaces for human beings

“one made beds to fit human beings, one did not chop off legs or hands to fit beds.” Lewis Mumford

psychological time

[TIME]

The form of the environment can also affect one’s conception of time; psychological time as opposed to chronological time, and a varied and rich spatial environment can have the effect of making the experience seem longer than it actually is. This manipulation of experience works at a very basic psychological level. For example, we may recall times in our lives when we have moved to a new city or started a new school, and the first few months felt like years. Conversely, subsequent weeks or months seemed to pass much more quickly. Similarly, when we are young, time seems to pass very slowly, whereas when we are older, the years tend to blur together. It all has to do with how we take in information in our environment. When we are in a situation where everything is new and we are responding to a lot of stimuli, then time seems to pass slowly. When an environment is familiar, it becomes a seamless blur, and time appears to go by more quickly.

[where we are affects the quality of our lives]

Literature and theatre often make use of the manipulation of time to further the desired message and experience, either speeding, slowing, or an interplay of each in the narrative. The broad sweep of time in Tolstoy’s ‘War and Peace’, the slowing almost to a standstill of action in Joyce’s ‘Portrait of the Artist as a Young Man’ or Sterne’s Tristram Shandy, or the freezing of the moment

epitomised by the Japanese haiku poem. Shakespeare, it is said, deliberately speeded up the action at the end of his plays to counteract the flagging attention of the audience. Analogously, architecture can be seen as a narrative of spaces and events, an unfolding story, that similarly manipulates one’s sense of time.

Thomas Barrie - ‘spiritual path, sacred place’ Shambhala

shining metal

She looked over his shoulder

For vines and olive trees,

Marble well-governed cities

And ships upon untamed seas,

But there on shining metal

His hands had put instead

An Artificial wilderness

And a sky like lead.

W.H. Auden

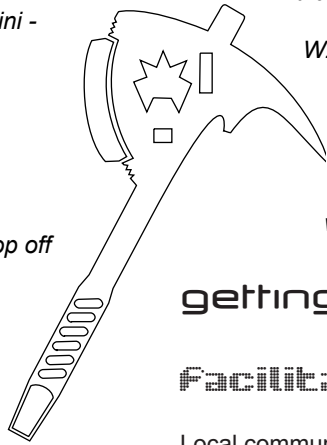

gropius

“who will build gardens out of deserts and pile up wonders to the sky.” Gropius

getting outside

facilitating community

Local communities can be brought closer together if common interest is allowed to intersect with location in a more efficient way. Why should people in a town not be able to establish more accurately where the people are who share their interests.

On the street where you live, the block where you live, the neighbourhood you live in, how many people do you know? And if you wanted to meet the subset of those people you might have something in common with, is there any reasonable way to do it without waiting for ten years worth of arbitrary random interactions.

proximity

What if there was a system that could establish that someone like you was sitting around bored in the next street, that you had a mutual friend in common and the system can arrange to introduce the two of you, in a way acceptable to each of you.

Leverage proximity better.

Space games

What if you had to run around and climb things to play computer games rather than sitting in a room listening to headphones.

Imagine games which involved spatial challenges, and involved whole communities of kids, both building the levels and playing the games.

'go to the end of the road and climb on the roof of the deserted cinema'

or rather (introducing a time element, and in order to get the next instruction)

'RUN to the end of the road and climb on the roof of the deserted cinema.'

Such games might result in a few fatalities, but at least it would get kids out of the house.

mechanically regulating community

Church clocks predate personal time keeping.

The clock strikes loud to regulate a community otherwise disconnected from awareness of mechanical time.

In this small Japanese village a megaphone wakes the whole community up in the morning, barks advice during the day and plays a lullaby at bedtime.

seemingly innocent English villages

Remember those Hammer films, or those episodes of the Avengers, when seemingly innocent English villages turn out to be living according to entirely different and usually malevolent rules and regimes. 'The Wicca Man' being the definitive example, a policeman (Edward Woodward) arrives on a small island to investigate the disappearance of a young girl, he slowly establishes that he is in a thinly disguised pagan community. At the end they trap him in a large Wicca man and burn him to death according to pagan ritual practice.

In the absence of visual cues, and given the extent to which people can be permanently connected to distributed communities, it is going to be harder to make assumptions about people and their communities and affiliations.

Dualities

A person may seem to be one thing and turn out to be quite another.

double meanings (Howard Hughes hitch hiking)

"A recent tragic example of this occurred in the small town of North Zulch, Texas. There, some rural law enforcement officers apprehended a scruffy vagabond on a motorcycle after a high speed chase. Unfortunately he was killed. A search of his backpack revealed a device the size of a cigarette pack. The police officers, who were not computer literate, accidentally broke the device. This tiny device was actually a privately owned

computer bulletin board system with some 15000 registered users."

Bruce Sterling. Wired 1.4 Page 91

the richest most satisfying playground

Ignore mental abstraction for a moment in favour of physical reality. The real world is beautiful and complex and detailed.

simulation

I remember driving down a motorway on the way out of London once and seeing a tree in bright late afternoon sunlight and (after having spent too much time over the previous couple of months in dark rooms with 3d studio and photoshop), feeling struck by how much detail there was in the tree and how well rendered it was. This seemed like a dark thought at the time. Later on I worked at a company that worked on real-time physics simulation, and the implication (and motivation) was that reality could be simulated not just visually but at a deeper more fundamental level. Ultimately the simulation would be a satisfying alternate reality.

The vision of a 21st century games console hooked up by a fat pipe to the network, with accurate physics, stunning rendering, AI and other people to play with or against is still current. It is coming to pass in the shape of the Playstation 2 and the Microsoft X box. But it all seems rather dull and peripheral relative to the real revolution. The internet doesn't need 3d, it certainly manifests in 3d, in the form of Quake, but it is not fundamental to its success or growth. Interesting but not core, not fundamental.

outdoors

The outdoors has been refined into an urban playground on the one hand, or a backdrop for extreme sports and 'nature' on the other. In some real sense it has already become a stage set.

The idea that you can now make a phone call from anywhere means the notion of wilderness is now defined by personal economics and technology rather than geographic location.

A friend of mine who recently returned from Africa told me about the battles and alliances in the bush, where multiple film crews from different networks and natural history programs were attempting to get shots of the same animal without getting each other in the shot. The noise and the lights and the generators transformed the wild into something else, but the product would ultimately be cut and dubbed to reflect the idealised image of 'nature' that audiences demanded

Mountaineers queue up to climb once rarefied and remote mountain peaks like Everest and K2. Western sport climbers bored of Thailand are bolting routes in Cambodia and Vietnam, widening their field of play. Snowboarders are helicoptered into remote areas to board down inaccessible runs.

Kids in urban areas skateboard, rollerblade and bike their way over every conceivable urban obstacle. Technology just makes outside more fun.

the space program

Two things are experiencing explosive growth, the internet and cell phones. Now the two phenomena are about to get integrated. From anywhere on earth for a relatively small amount of money you will be able to send and receive information including your geographical position.

During the sixties the space program began in earnest. From a cultural stand point it represented some assumptions: that there would be something on the moon when we got there and that actually going there was worthwhile.

When NASA abandoned manned missions to other planets, it represented a shift from an externally focused world view to an internally focused world view. From a belief in an outside that was worth reaching out for, to an obsession with creating internal worlds.

Computers have dominated our lives since that point, and the computing experience is epitomised by sitting at a screen and focusing on abstractions.

The idea of building whole worlds inside a computer, of not having to travel to real places because we have cameras and sensors that can tell us what is there persists, as does the conception of a computer as a complete internal world we can inhabit without leaving the safety of a bedroom.

Geography is unimportant we are told, communities, trade, communication, all are free of geographical constraints as a consequence of the internet. But communities of real people should be able to meet in real life, trade would be more efficient from at least a logistical point of view it were sensitive to geography, and communicating with people who share a common interest locally can be more interesting given that you might be able to actually talk to them at some point without traveling to the other side of the world.

The frictionless abstractions that the internet has facilitated have already proved there worth, but imagine if those abstractions could be further leveraged to increase there potency.

Mobile phones are already augmenting reality in the moment. I can walk down the street (or through the bush), decide I need to know something, or talk to someone, and call to get an immediate resolution to my need. ('I'm lost, are you sitting in front of a computer?' or 'Melanie, you know about plants, can I eat these yellow berries..')

1-800-questions

signs

The world is already full of external and consciously (and unconsciously) constructed visible symbol systems, advertising hoardings, street signs, bar-codes, lists of ingredients, post-it notes, shoes hanging from tram wires, clothing, architecture. All of which make reality richer more interesting or easier to navigate

One day there will be no visible signs. Or rather, visible signs will persist but the invisible visible (or audible) signs will be more important.

Knowing where I am and what I'm doing I can ask the network to tell me what information I should see or hear that would be useful

or relevant given my position and interest.

Real signs might be reduced to machine readable symbols that just exist to link to the relevant information on the network. I read in the symbol on the engine block of my car and a repair manual (or voice link to a mechanic) opens up. Knowing the location of a wooden box exactly I could place a note in it without it actually being there. I could leave a huge burning skull in a restaurant I decide I don't like.

augmentation precedents

The success of the film the Matrix was built on a vision of a digital world as complex and rich as our own. The interface to the outside (the real world) was a cell phone [Nokia].

Neo: I need a little help

Operator: door on your left [Neo tries the wrong door] ...no your other left

Morpheus at one point in the film asks the operator for a structural architectural plan of the building they are in.

The film can be read in a number of ways, one of the readings is as a key reality augmentation film, with just a cell phone the field operative can get any kind of information or help needed.

[Having an argument at the checkout at Safeway and calling in an airstrike from your cell phone.]

Good film precedents for augmented reality technology include Terminator 1, which came out in the early eighties before 3d graphics were being used in films. The Terminator uses a 2d head up display which can supply schematic diagrams, telephone directories, appropriate things to say and basic useful information like how to drive a truck. If anything that functionality is short of what is now possible.

Neal Stephenson's 'Snow Crash' has characters who do nothing but gather arbitrary data using cameras and other sensors attached to there bodies. The information is fed to the library of congress and the data gatherers only get paid if anyone accessing the library uses information they have gathered.

Another precedent is military technology, night vision, HUD's, GPS, the whole C4i (Command, Control, Communications, Computers, and Intelligence) infrastructure.

For some time now wearable computers have been an area of interest in geek circles, at MIT and elsewhere, cameras and displays strapped to the head, keypads sewn into jackets, computers in shoes.

At siggraph 99 there was a demonstration of a machine readable symbol system that would link to information on the net if it were scanned, scanning was done using pattern recognition and a worn camera.

All this reliance on gear is a little tedious

Cellphones (some location aware) with an internet capability are a reality. This is sufficient to begin moving in the right direction. Having said that, retinal displays exist and will soon be available and cheap, and as people become aware that the ability to augment reality is no longer just a geek dream but a mass market

reality, peripherals will appear and get refined.

persona vitrea

“...or Persona Vitrea (a mask that does not hide but, rather, reveals)”

senses

Devices can enhance your senses and give you a different way of thinking about your environment, a conventional paper map and a compass significantly augment your ability to not get lost.

People have walked to their death off cliffs in fog, blindly trusting the reading on their GPS.

From an extreme empirical point of view, you are constantly making assumptions based on your model of the world rather than the strict information your senses are receiving.

If you augment your senses artificially and feed that model additional information what harm?

‘...you move forward feeling with the back of your hand because if you touch something red hot or electrical with your hand facing forward that hand would clench automatically and you couldn’t unclench it.’ [paraphrase of 1950’s British fireman describing moving through smoke filled buildings].

the flat sided deep

“the abyss of the five senses, where a flat sided steep frowns over the present world” William Blake

incompleteness

“Although the landscape before my eyes may well herald the features of the one that is hidden behind the hill, it does so only to a certain degree of indeterminacy: here there are meadows, over there perhaps woods, and, in any case, beyond the near horizon, I know only that there will be land or sky and, as far as the limits of the earth’s atmosphere are concerned, I know only that there is, in the most general terms, something to be perceived, and of those remote regions I possess only the style, in the abstract. In the same way, although each past is progressively enclosed in its entirety in the more recent past which has followed it, in virtue of the interlocking of intentionalities, the past degenerates, and the earliest years of my life are lost in the general existence of my body, of which I now know merely that it was already, at that time, confronted by colours and sounds, and a nature similar to the one I now see before me. I possess the remote past, as I do the future, therefore, only in principle, and my life is slipping away from me on all sides, and is circumscribed by impersonal zones. The contradiction which we find between the reality of the world and its incompleteness is the contradiction between the omnipresence of consciousness and its involvement in a field of presence.”

M. Merleau-Ponty, *The Phenomenology of Perception*

i trust it more than my eyes.

“I’ve got this little Hi-8 camera which I’m taking everywhere because I trust it more than my eyes.” Terry Gilliam

place the organising principle

Location aware wireless, mobile, devices can use geography as an organising principle. A knowledge of the place you happen to be can establish a context for your requests. Where you are affects your information requirements and the behaviour you expect from your device (if you are in a theatre you don’t want the phone to ring).

seven league boots

email

To: Cornelius Tacitus

From: Gaius Plinius Luci

I know you will think it a good joke, as indeed it is, when I tell you that your old friend has caught three boars, very fine ones too. Yes, I really did, and without even changing any of my lazy holiday habits. I was sitting by the hunting nets with my writing materials by my side instead of hunting spears, thinking something out and making notes, so that even if I came home empty handed I should at least have my notebooks filled. Don’t look down on mental activity of this kind, the mere fact of being alone in the depths of the woods in the silence necessary for hunting is a positive stimulus to thought. So next time you hunt yourself, follow my example and take your notebooks along with your lunch-basket and flask; you will find that Minerva walks the hills no less than Diana.

information reconfigured according to context

Geographical context impacts upon the information you need and your range of action.

‘Find me a way back home’ [get a map from this location to my house]

‘Show me all the restaurants I’ll like within a mile radius’

‘find me a bookshop’

‘I need a bus downtown, where do I go to get one, what number should I take, how much will it cost and how long will I have to wait’ [nextbus]

the observer at the center

“Everywhere there is incessant relative change in position throughout the universe, and the observer is always at the center of things.” Giordano Bruno

contingent on the interests of the beholder

“A liquid architecture is an architecture whose form is contingent on the interests of the beholder”

“Liquid architecture makes liquid cities, cities that change at the shift of a value, where visitors with different backgrounds see different landmarks, where neighborhoods vary with ideas held in common, and evolve as the ideas mature or dissolve.”

Marcos Novak, *TransTerraFirma: After Territory*

the tyranny of categories

TN: “I’ve always felt tyrannized by categories. The answer is not to eliminate categories but to provide a means whereby categorization is recognised and becomes harmless - like celluloid overlays. The same material should be categorizable and recategorizable every way possible by different people. We’re speaking here in the context of tomorrow’s publishing.” Ted Nelson [interviewed by John Perry Barlow]

the observer augmented

Life looks different depending on who you are with. If you have a guide it changes the way you see a place. If a device gives you a personalised view on an unfamiliar place, it changes your experience of that place.

‘show me all the yoga studios, climbing walls and vegan restaurants, and find me a friend with a sofa I can sleep on.’

Information can make the unfamiliar familiar.

behind the next hill

I live in a box, I walk down the street and I pass other boxes. Occasionally I see someone briefly at a window, I somehow know that there are people in all the boxes, that there are lives going on all around me that I cannot see. So much is taken on trust and the percentage of other lives that I see with my own eyes is small. Media feeds the feeling that I have a grasp of what is going on around me, and dulls my sense of distance and dislocation from the world. I think I know what other countries are like, what other parts of my home town are like, what other people are like, based entirely on information derived from media rather than personal experience. People are always different when you meet them, even if you know a lot about them

Zero media is a ‘year zero’ position. Seceding from passive media is quite common, lots of bright people I know don’t watch TV or read newspapers. They don’t trust the mass media, it seems to be feeding them a false sense of knowing and comfort, and dulling their capacity to know and act in the real space. How distanced is the news from the event it reports on, how much do I really know about the real experiences of others from having them presented to me on television in my living room. Doing a thing or

being somewhere is always different than I thought it would be, even I’ve seen it done or been told what its like. The media offers me something, but not the experience itself. It can offer me a clue (and that can be a good thing), bad things have happened in former Yugoslavia for example, but I’d have to be there to begin to know what the pictures mean.

Cutting the media umbilical chord changes the whole shape of the world. Everything changes, you think about the space differently, you do more, you have more time and you make more of an effort to actually see rather than relying on mediated sources, rather than grinning mindlessly.

Cut television out of your life and life changes.

‘It was three days, before I was told that Princess Diana had died (very weird), I noticed a Union Jack at half-mast over the engineering building (extremely unusual), jets flew over Oxford in formation.

I overheard a conversation

‘how was London yesterday?’

‘lots of flowers, flags at half mast’

No information to tie all this together. And why should there be? It wasn’t a direct part of my life, I wasn’t tied into the mass media so it didn’t reach me.

Ironically you still hear about everything eventually anyway. People tell you things that only make sense if you assume some context you have no direct grasp of. I knew there were Spice Girls because people told me Spice Girls jokes.’

I have some vague model in my head of countries I have never been to, I trust that they are there and that if I boarded a plane and headed in the right direction that place would be, at least very roughly, as I had expected.

How to enhance appreciation of the world around you without, becoming dulled by a false sense of knowing.

Subordinate all information about an experience to what you consider to be the real experience.

guides

I want to have access to every conceivable kind of guide. I want voices to tell me about the place I happen to be in. I want to see the footprints of local people showing me how they navigate the space. I want to be able to ask for help of any kind and get it. I want to be able to call in air strikes at safeway.

degenerates

Enable subcultures to orientate and organise the chaos spontaneously.

Spontaneous gatherings, actions and insurrection.

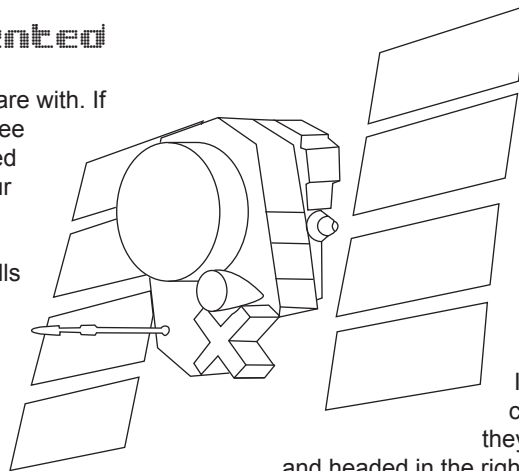

'everyone within a six mile radius, get here now'

geomesh infrastructure

wireless networking as a precursor to augmenting

In the wake of huge investment in high bandwidth wireless networking, the networks that are evolving are different from their wired predecessors. The world wireless networking makes possible is still to be built.

A world will emerge in the new spirit spontaneously and it will take time to establish its characteristics and determine its shape.

connect everything to everything

"The central act of the modern era is to connect everything to everything" Kevin Kelly

semantic reality

the initial impulse to connect everything to everything has already started to mutate into connecting everything to everything in a meaningful way, the semantic web adding meaning to the elements of the network (data) and to the links between the elements (creating vocabularies to describe the nature of a given link).

the expansion of the highway system

"In 1919, Major Dwight D. Eisenhower had led his motorised military expedition across the United States with barely a road system to follow. It got him thinking about the motorways of the future. Thirty-seven years later, in 1956, president Dwight D. Eisenhower signed the Interstate Highway Bill, which provided for a 41,000-mile superhighway system (later raised to 42,500 miles) that would crisscross the nation. The Federal government would pay 90 percent of the cost, with most of the money coming from a specially designated, non-divertible highway trust fund accumulated out of gasoline taxes. The program was actively advocated and promoted by a broad coalition of interests that became known as the 'highway lobby'- automobile makers, state governments, truckers, car dealers, oil companies, rubber companies, trades unions, real estate developers. There was even the American Parking Association; after all, no matter how great the distance covered, drivers would eventually have to come to the end of their trips - and park their cars.

Eisenhower himself advocated the interstate highway program on several grounds: safety, congestion, the many billions of dollars wasted because of inefficient road transport, and, evoking the darkest fears of the Cold War, the requirements of civil defense. "In case of atomic attack on our cities," he said, "the road net must permit quick evacuation of target areas." The resulting program was massive, and Eisenhower took great pride in the scale of the construction, using wondrous and mesmerising comparisons. "The total pavement of the system would make a parking lot big enough to hold two third of all the automobiles in the United

States," he said. "The amount of concrete poured to form these roadways would build eighty Hoover Dams or six sidewalks to the moon. To build them, bulldozers and shovels would move enough dirt and rock to bury all of Connecticut two feet deep. More than any single action by the government since the end of the war, this would change the fate of America." His words were, if anything, an understatement."

The Prize - Daniel Yergin

internet is not the same as Freeway

The internet is not the same as the freeway network in America, but it has some themes in common.

The internet was designed to be able to survive a nuclear attack and at least a stated proposed use of the highway system was to enable evacuation during a nuclear attack.

Despite all the focus on internet companies like Amazon and Yahoo (the dotcoms), the real economic issue is not the companies that claim to be the commercial internet, but the fact that like freeways, the internet just changes the way information and goods flow through the system. If the internet is having an impact on the real economy it is because it is affecting the way all transactions are being conducted (taking the broadest definition of transaction to include receipt of information, email, trade, website hits etc.).

a spatial external network

Unlike the internet, the freeway network is external and deals with the movement of goods and people as well as information.

augmenting the road system - parasitic technologies

The freeway network also represents a nexus point for the convergence of internet access and wireless location aware devices.

The freeways reshaped America, they conjured up suburbs, malls, motels, restaurants and gas stations. They reinforced America as a huge homogenous market that distributors could easily supply. They enabled easy migration from anywhere to anywhere. Given the level of mobility already built into American life and consciousness (LA is a great big freeway). What will the result of the addition of a new layer of technology augmenting this infrastructure conjure up. Cars will be location aware and connected to the internet. Driving through some remote valley you will know if something interesting is happening outside your field of view, or if a particular town is worth stopping in, or if someone in your extended community lives nearby. Your immediate surroundings can become more than just scenery merging into an irrelevant blur.

coordination and support of Field operatives

"I asked the major over wind and noise about the strange warning sign that had caught my attention early in the morning. "Desert tortoise," he shouted. "Fifty thousand dollars if you kill one." "The scientists claimed to be matching the warfighters chip for chip in the information war. Tortoises were tagged with transmitters, tracked by radio telemetry, and graphed in grid locations by

computers. Landsat satellites were used to identify good habitat areas, aerial mine detection technology to find tortoises moving on the ground, and electronic sensors to warn off vehicles that might endanger the creatures." James Der Derian - *Cyber-Deterance* [Wired 2.09]

military origins

the military gave us GPS, head up displays, computers even. C4i (command, control, communications, computers and intelligence) integrates all kinds of technologies, to augment the capabilities of troops in the field with every kind information and support, and to supply commanders with a model of the entire theatre of operations.

prototypes

The technology developed to equip special forces for the next low intensity conflict.

Even less technologically advanced, and civilian orientated, forces are useful for determining precedent.

Police forces around the world make heavy use of the radio. Radio communication is a fundamental capability upon which command and control can be built. The radio links back to a command centre, full of operators in contact with officers, with access to information (maps, databases etc.) men, vehicles and equipment.

This kind of support infrastructure is what is being made available to civilians through the convergence of cell phones and the internet.

the ally

THE NATURE OF THE ALLY

The old doctors had helpers

Maybe the power plant was a conduit, or a call, a sort of whistle. Or the plant was like a delivery service. Not like the plant itself was the ally

maybe the ally lived in the plant, or maybe the ally lived in the next world, and the plant was like a bridge

That plants have virtues, or 'vertues', was known by the ancient herbalists. The Virtue of a plant was its truth, its strength. Maybe the best synonym is integrity. Or power. Or poison.

The ally is the one who helps you. That is what an ally should do. Allies assist each other in the prosecution of some task.

Allies may also have agendas of their own, however. That is, an ally is not like a fairy-godmother, but is a powerful force in its own right.

An ally is like a half-broken horse, a horse with spirit. A horse that will carry you many days, only to suddenly knock you off on a low branch. Some allies are the subtle type. Maybe You have an ayahuasca sally. She is friendly. She gives you things. She doesn't seem at all malevolent. Or maybe you have an opium ally. She is more than friendly. She'll call you up and invite you over. And she is voluptuous, so you go. She is so good to you it seems like

heaven. You get what I mean.

Pharmako/poeia - Plants, Posions and Herbcraft by Dale Pendell, mercury house san francisco 1995

instant tools

Aborigines have few tools or objects and rely on 'instant tools', that is they recognise potentially useful objects in the environment. If this object matches a 'mental template' or idea of a tool, for example a spear thrower, a concrete object results.

Group members share food as well as other possessions, and among aborigines articles have been traced through 134 persons. This sharing creates friendship and social values are more important than economic ones.

Hunters do not store food but regard the environment as a storehouse. While each local group is associated with a geographic range there is considerable visiting among groups which do not maintain exclusive rights to resources but have flexible arrangements. At the same time most groups have a home base or camp.

This generalised description of the way in which hunters and gatherers (including aborigenes) use space can be expressed in terms of a set of concepts derived from animal studies

Home Range - The usual limit of regular and activities, which can be defined as a set of behavioural settings and linking paths.

Core areas - Those areas within the home range which are most used and most commonly inhabited.

Territory - A particular area which is owned and defended - whether physically or through rules or symbols which identify the area of an individual or group from others.

Jurisdiction - 'Ownership' of a territory for a limited time only, and by some agreed rules.

Among animals the size of home range and core areas and their coincidence, and the times and duration of jurisdiction depend on the natural conditions (climate, rainfall, resources) on the one hand and the animal species on the other. In the case of hunters also the same physical factors play a role as do the values and life-style of the group.

Amos Rapoport - AUSTRALIAN ABORIGINES AND THE DEFINITION OF PLACE found in Shelter Sign and Symbol ed. Paul Oliver - Barrie and Jenkins 1975

mesh networks politics and law in software

software as constitution and law

[users]

Any piece of software has conventions and methodology that govern you while you use it. You have to work in the way the software prescribes. Hotmail conditions the way you use email. Micro-

soft Word conditions the way you write; it forces you to capitalise words at the beginning of sentences when you don't want to and alters the spelling of the words you misspelled on purpose. In fact all Microsoft products condition your behaviour. They proscribe the way you carry out the task they are helping you perform. You are governed by an imposed constitution and law, by the philosophy of the people who wrote the software.

Software is often reconfigurable and extensible, the environment you are working in can usually be radically changed to suite the way you work. Microsoft Word for example is actually massively reconfigurable and below the surface is very powerful. In the hands of a Microsoft Word guru, Microsoft Word can do almost anything (one of the reasons why there are so many Microsoft Word viruses). Even a dumb user can stop it from correcting their spelling. But most people don't customise their environments and live under the tyranny of the software's defaults.

linux

In the Unix community hackers fight religious wars in defense of their preferred on screen working environments. The arguments centre on questions like whether a particular editor is less intrusive or more flexible or powerful, and the tone of the arguments imply that using a particular editor implies an entire world view.

The arguments extend to operating systems. Being a Unix user or a Mac user or a Windows user implies differences in your whole way of life.

Beyond editors, hackers have the way they work, the way they write code, conditioned by operating systems.

Consequently we have Linux. Linux is an entirely free operating system, with all of its underlying code available for anyone to peruse and hack away at. Generalising somewhat, the Linux community see the collective development of Linux as a political act. Linux represents freedom from the tyranny of closed and arbitrary constitutions. The Linux community sees itself in direct opposition to the closed orthodoxy of Microsoft.

addapt

Addapt [www.addapt.org] is an experiment in developing networked community. Addapt was developed by Rich Persaud as generic community building software.

Each member of an addapt community has a profile. If you want to see the photo of another member you have to submit one of yourself. If you don't submit a photo of yourself you can't see anyone else's, if you don't submit a bio you can't see anyone else's.

You have to contribute to see what others have contributed.

No spectators.

chess

"Chess is an example of how a fixed set of rules does not restrict freedom but rather creates freedom" Herman Hertzberger

the landmark lessig ruling

This is the final statement, at the end of the last of the P2P file sharing cases (which was presided over and concluded by Shakil Meritam, who some considered the ideal geek judge).

It was directed at artists and programmers of all kinds but specifically at the 22 year old singer who had filed the prosecution case.

The summation took place in late 2005 at a point when the Lessig presidency was forcing through the fastest most far reaching legal and political transformation in American history.

Shakil, a young judge at 33, was a man who had some empathy for artists having written some really clever and much respected open source code in his younger days.

"This ruling will be hard to swallow if you were comfortable in the old world, but in the light of the recent dramatic world events and the logic of the new administration, and specifically the landmark majority verdict reached by the recently repaired Supreme Court, it's clear that not everyone was. Let me outline where we are now with respect to this case.

It is my greatest regret that it will affect artists themselves not just the parasitic industries that have grown up around their talent. Those of you, for example, that make a living directly from writing or coding or making movies or singing,

The essence of my ruling, which follows from the technical and market realities as this court perceives them, is that you can still charge for access, and for physical things, but you cannot impose constraints on the redistribution of bits.

Also there is no change, despite the prosecutions arguments concerning the technical difficulties of enforcement, in the Supreme Courts caveat ruling against abuses of personal data privacy. Aggregating or redistributing personal data without explicit permission is still unlawful.

The truth is that copyright as we used to understand it wasn't just easier to uphold because copying was hard and distributing was easier to control, it was predicated on it. The law can only help you so far. Copyright as we used to understand it was reasoned, and in some cases reasonable, opportunism based on technological circumstances.

I have not ruled that all the ideas behind traditional copyright should be abandoned just that they should only apply where it makes technological, political, and social, sense.

I'm sorry you steal feel they stole your work, I have to confess I even have some mp3's of your songs myself. I really like your stuff. But heres the position: I can't allow you to invade privacy, lock everyone of us up, cripple everyones machines and remove useful functionality just so you can buy a huge condo and a private jet.

What I can do is sign you up early for the new 'artists wage legislation' that you and the recording industry are so bitterly opposed to. That legislation, as you probably know, gets users (people mostly) to register their media downloads.. Based on the download measure you can get paid the new 'artists wage' (on a sliding scale based on popularity). The system is not in place yet and It'll be hard to do and hard to verify, but i think its going to work out fine.

That will give you just enough to live on, and maybe a bit more cos its you and you're a really popular strategic propoganda asset of USA inc.

After that you might want to consider this:

I am not abolishing the market, all of the underlying principles of copyright, or money, as some old (and controlled) media headlines have suggested.

Neither am I removing all your possible means of supporting yourself or growing wealthy.

This and the points i will now make are not facetious, they are the consensus reality my ruling subjects you to,

If you want to keep the public from just 'stealing' what you have and not giving anything back you will have to alter the nature of what you give them and the way you give it to them. It is my view that despite your denials you have already gone some way towards this reality.

I'll try and give you some examples of what I am suggesting.

You could make something real and not reducable to bits (but still distributable) and make it intrinsic to your bit reducible art.

You can require or suggest real things to complete the digital experience (or become marketing material for harder to reproduce and easier to control goods) and make money that way (incidentally if you were thinking of arguing the point that logically follows that - at the point at which everything is easy to reproduce, money won't matter so much anyway.)

What I am suggesting, you and your industry already well understand. Acknowledging these unwritten rules (not locking down copyright) will lead to innovation beyond the computer screen. That is, it will be good for the transfromation of physical reality..

To get a user to pay to view or listen, you must make your work more satisfying if viewed in a complex, hard to reproduce setting. People will pay in those circumstances. Moreover the law will back you if you ask them to pay for access and they try not to.

..that doesn't give a license to cripple copying and distribution mechanisms (look how much good feeling that generated)

I'll say again I can only help you protect physical things and access to streams of bits, but not the bits themselves.

You can argue as long as you like about the supposed injustice of that, but it is your reality and you must learn to live and survive in that reality.

You can still get paid. You could create an environment that is always on, ever changing and that fundamentally requires real time interaction. That is, an environment that is only relevant when connected. You could then charge people who want to be connected to your world. You can charge for an account on the server, specifically *not* the client software, or a *track* or what happened yesterday.

Offer a real time service not a dead chunk of data.

The industry that funded your appeal had an opportunity early on to build a culture of subscription for tracks and movies but you blew it for the sake of greed, and i can't put that genie back in the bottle for you.

I ask you to think of George Lucas realising the potential for star wars toys,

Different kinds of artists and creative industries have evolved different approaches in each new creatively, technologically and legally constrained circumstance and they *must* continue to do so.

here are some of those historical, extant approaches, that prove my point about creative industries understanding these ideas prior to the new legislation:

Sell fast machines and graphics cards (video game tactic), public performances and tshirts (music tactic), big cinema + blobject + mcdonalds license (film tactic), physical books and rubber chicken circuit (author tactic), the unfeasibly huge freeway sculptures by Arnish Kapoor in LA (fine artists tactic)

Face it, you go and see 'Lord of the Rings 4' in a cinema because it is more satisfying than watching the DVD on your laptop, and you pay because you want to be there and they own the building.

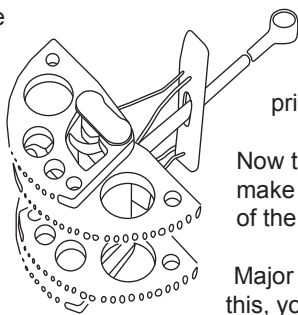

You bought a computer because without it you couldn't see the DVD.

You read a book cos at the moment its easier than printing out the hacked PDF

Now think of all the bands that get paid to play live and make all their money selling tshirts from a table at the back of the hall

Major commercial artists and producers already recognise this, you realise this, and you just want to get paid many times over. Which is OK in principle, but if one of those ways you want to get paid requires crippling peoples computers and slowing down the flow of digital information then that way is *not* OK.

Access rights I can enforce, privacy rights i will try and enforce, dead data redistribution rights i can't.

I think the honest way forward isn't crippling the machines it's constant evolution and imaginatively binding digitised art to reality in *new* ways

In physical terms i think that means more than t-shirts.

..to be valuable within this new legal framework data can be bound to the outside, to the physical world and to the real presence of the artist

From a marketing perspective companies like Nintendo already recognise this: look at their swipe card trading cards, but i'm afraid even that falls short of my ruling

Mobile computing has already opened up the possibilites and not just to marketing scams but to real innovation

Location aware games now allow locations to be critical to games and you often have to pay to get in to a game critical location.

This legislation is a carefully considered challenge to artists, The public won't let you starve because we like your stuff (or some of us do) but i'm afraid today we want more from you.

don't just make things reducible to dead sequences of bits

you must now take responsibility for (and the rewards that follow from) transforming physical reality, don't just sing into a computer for three minutes about change and hope someone else does it

you're likely to get paid if you change the outside (or force a change in our real time experience of the inside)

On your way out, remember you have a mighty and unfettered network that wants to hear and see you

and you can use that network in innovative ways that i haven't forseen, you can also use the digital media you already know how to create, distributed free, to support your efforts to transform reality. And if it matters to you and you're clever or you partner with the right people you could get paid a lot of money for finding a commercial interpretation of this landmark ruling.

..and finally remember that your physical presences as an artist increases in value according to the square of the number of mp3's that people 'steal'. It was a real buzz to spend so many weeks with you."

[entirely ficticious first draft written after a late night with no references to real persons living or dead - no warranty real or implied - and protected by the full and ominous force of ever expanding copyright law]

headmap received this important clarification by email shortly after this was written

"note that the audience's untitled, emotional farmland is a single-use commodity that will be recapitalized by many industries external to the "music" industry

imprinting certain songs on the brains of a teenage audience during their formative years serves as a selection mechanism for future radio stations, commercials, period movies, etc

the period of harvesting the fruit of these early seeds is when the onetime teenagers reach their early-thirties - old enough to have earning power, young enough to have disposable income (low chance of mortgages, kids, etc).

the teenagers' attention should be treated as part of a transaction ... companies that engage said attention are benefiting from a (re)transmission medium for which they are never billed ... and can never be reused ... formative memories (imprinted on virgin minds) are never lost or less intense than their successors.

songs are like links in blogs ... molecules that anchor chemical reactions, given appropriate catalysis ... they are chrono-emotio-spatial hash signatures by virtue of early binding to formative experiences

the limited resource, the economic resource is not the songs ... it's the formative experiences ... which are being sold in an invisible transaction that commits the memory's owner to a lifetime of subsequent heartstring-pulling ... unpaid and involuntary.

the music industry can and does make money by selling performance rights to these songs, into infinity ... even if _all_ the songs

were given away for free on P2P networks ... they are an anonymous sorting mechanism ... the only problem is the 17-year gap between binding the song to a memory and harvesting the disposable income of the memory's owner." Rich Persaud

social organisation

twelve principles of collaboration

12 Principles of Collaboration

[from mongoosetech.com]

Purpose

Community exists because the members share a common purpose which can only be accomplished jointly.

Identity

Members can identify each other and build relationships.

Reputation

Members build a reputation based on the expressed opinions of others.

Governance

The facilitators and members of the community assign management duties to each other, allowing the community to grow.

Communication

Members must be able to interact with each other .

Groups

Community members group themselves according to specific interests or tasks

Environment

A synergistic environment enables community members to achieve their purpose.

Boundaries

The community knows why it exists and what or who is outside and inside.

Trust

Building trust between members and with community facilitators increases group efficiency and enables conflict resolution.

Exchange

The community recognizes forms of exchange values, such as knowledge, experience, support, barter or money .

Expression

The community itself has a "soul" or "personality"; members are aware of what other community members are doing.

History

The community must keep track of past events and must react and change in response to it.

heterarchy

technological constraints on organisational structure [e.g. distance and time] are changing

There is as yet no new social framework that is as interesting as technology, and ideas, now allow.

a new dominant form of social organisation

"It is the shift from hierarchy to heterarchy, which is still in progress worldwide. ("Heterarchy" was coined by early cybernetician Warren McCulloch at MIT to designate networked structures in which the center of control constantly moves to wherever is most relevant and useful; he was thinking of brain function.) At a time when the New Left was calling for grass-roots political (i.e. referred) power, Whole Earth eschewed politics and pushed grass-roots direct power - tools and skills." Stewart Brand on founding the Whole Earth Catalog in 1968

the network is the new dominant form of social organisation

the emphasis [...] is less on the advance of technology than on the challenges for organization"

netwar is not simply a function of the Internet; it does not take place only in cyberspace or the infosphere. Some key battles may occur there, but a war's overall conduct and outcome will normally depend mostly on what happens in the real world."

Netwar is not Internet war.

the information revolution is not solely or mainly about technology; it is an organizational as well as a techno-logical revolution.

Consider the four major forms that, over the ages, appear to account for the organization and evolution of societies: tribes, institutions, markets, and networks (see Ronfeldt, 1996). Very different types of information - and different information cultures and strategies - pertain to each form. In the case of tribes (and clans), the most valued information is often about kinship ties; in the case of institutions, it is about the reasons for hierarchy; in markets, it is about opportunities for exchange; and, while it is still early to be sure about information-age networks, information about the capacity for team-work may be highly valued.

The rise of network forms of organization is a key consequence of the ongoing information revolution.

[Four examples of network organisation

- The chain network, as in a smuggling chain where people, goods, or information move along a line of separated contacts, and where end-to-end communication must travel through the intermediate nodes.
- The star, hub, or wheel network, as in a franchise or a cartel structure where a set of actors is tied to a central node or actor, and must go through that node to communicate and coordinate.
- The all-channel network, as in a collaborative network of militant small groups where every group is connected to every other.

Of the three network types, the all-channel has been the most difficult to organize and sustain historically, partly because it may require dense communications

In an archetypal netwar, the protagonists may consist of diverse, dispersed, often small groups ("nodes") who share a set of ideas and interests, and agree to communicate, coordinate, and act in a highly Internetted ("all-channel") manner. Ideally, this actor (or set of actors) has no single central leadership, headquarters, or command - no precise heart or head that can be targeted. The overall organizational design is flat and non-hierarchical - it is heterarchical, both polycephalous and acephalous. It functions as what might be termed a "panarchy" in that all members subscribe to a common doctrine that reflects their shared ideals and objectives, and guides their strategies. Tactical decision making and operations are decentralized - they may involve mutual consultation, but they emphasize local initiative.

from John Arquilla, David Ronfeldt, and Michele Zanini - see netwar and zapatista note for full text source

society as shelter

"our increased dependence on technological shelter may lead to the weakening of human interdependence, which is another source of security. We should not forget that society too provides shelter, and in many cases a more flexible and effective kind." Rosalind Williams - Notes from the Underground

domestication of grains made possible living in cities

"As ancient as wine is, however, beer is probably older, as attested by brewers Slops found on Neolithic middens. As Edgar Anderson says, man was a brewer before he was a baker. Some believe that brewing was the impetus behind the domestication of grains. The domestication of grains made possible living in cities, and it was living in cities that made possible imperialism, police, and slavery, which, in turn, led to writing, which led to, well, we all know: our present dilemma.

Ale comes from the Indo-European root alu-, relating to magic, sorcery, possession and visions, and is cognate with our word hallucinogen"

Pharmako/poeia - Plants, Posions and Herbcraft by Dale Pendell, mercury house san francisco 1995

community as value proposition (men are better than gates)

Measurable indicators of value (up until very recently) included 'eyeballs' and 'stickiness'

The community was the value proposition of many websites.

success was approximately equal to community

[...and the constituents of that community e.g. slashdot, linux]

military monastics [armies as communes]

peer to peer companies, klogs and blogcliques

here are commercial companies trawling and targeting blogs and selling what they find to corporate clients

this ultimately is one of the directions the knowledge management / klogs threads point

use the free stuff to make some money

seems like bloggers need a license or a mechanism that ensures that their writing is attributed and their contribution gets paid for if it is used in a commercial context.

ridiculously utopian to imagine everyone doing their thing, and getting paid if what they do gets exploited commercially

even so

creative commons as it stands is not enough

one alternative is companies like Sense who allow bright people to blog amongst themselves for the benefit of commercial clients

..another alternative is the decentralised company

the difference being: rather than either the suited trawlers or networked consultants model..

you have an active open coalition of openly (and privately) blogging individuals focused on a shared purpose

in the context of 'free and open' this is the open source model

but in a commercial context

all this feeds into the nagging feeling that variant forms of all these ideas are already well advanced

and there are some dark undertones already evident

its not a new thought that bloggers and bloggers are the end-game in advertising

bloggers with an audience can [and to varying degrees do] sell their voices [mentioning products and individuals and companies apparently in the context of a subjective open dialogue but

primarily to serve the individual, interest group or company they have a financial or other interest in serving]

this is the full on blur that guerrilla advertising seeks:

targeted advertising in the context of an apparently 'open subjective dialogue' is heavy duty hypnotic suggestion

no need for indicators, no requirement for a break in the discourse indicating 'advert for individual/company/ideology follows..'

its not as simple as it seems either

you want to get paid cos you're hungry [example deleted] or you need another titanium imac [example deleted]

you want to talk in public cos you understand that you're going to get the feedback you need to push your own ideas forward if you place them in the biggest open technically sophisticated network forum possible

so what to do?

get on with it

read critically

keep working

blogging really is doing for text and ideas what open sourcing has done for software

blogs are not just public diaries they are mechanisms for structuring thoughts and ideas so they can be ordered, searched, aggregated and trawled

look what open source (with its often contrasting and diverse motivations) has managed to drag into a world a lot of people tried to keep closed

[..but maybe think about this stuff]

..and then there's the politics of blogcliques that coalesce and exist only to keep each other permanently overflowing with links back and forth [to be fair: often a mix of reasonable talent and machiavellian instincts]

the blogclique is distinct from the blogroll because blogcliquer's are making sure they all get paid and stay in the news, industry pundits, journalists, industry insiders, freeloaders and hardworkers allied with a common goal - not to disappear from view

blogclique behaviour gets even more interesting when two or more blogcliques from different spheres of influence combine to make uberblogcliques..

[begin paulo valdemarin P2P companies quote. via Ben Hammer-sley]

"Along all the .com era, all new companies that have been created were after all "traditional" companies, meaning pyramidal structures with managers, employees, offices, etc.

In the last few months I have met (most of times virtually) some very smart people from all parts of the world I would like to work with: to start new projects, to create new technologies, to develop new solutions. But when I think about how this could work out, I

keep bumping in the same old "company" idea. We could work together, with the ultimate goal of creating a new company.

But is this really the way to go? With the kind of collaborative technology that we have today, do we really still need companies?

Well, of course, the answer from many points of view is still yes, but it could be a whole new breed of company: a P2P company.

It could be something between a secret society, where all members are somehow guaranteed by other members and are supposed to help each other (of course, this should not be secret!), eBay, where everybody has a "digital reputation" (co-workers and customers commenting on different members of the group) and a true P2P network, where everybody is both a client and a server (there's just people working together, not necessarily anybody is working for anybody else)."

"the human propensity for noticing outliers in statistically opaque data.

it turns out this is a phenonema that people who appreciate music are quite familiar with. you will be listening to a song, and then you will hear a very faint hint of a new direction in the melody - your ears amplify these outliers and soon you are waiting for it to really pick up...

the point is that it is not major trends that people necessarily listen for; but hints at novelty - and a blogging scavenging business would likely do quite well... could affiliate with some of the venture capital firms, and make strong efforts to make people aware that they will be credited for their concepts.

god, have to do some work now! will kill email for a couple of hours."

Anselm Hook

transcend mob mentality

[stig quote]

"what's interesting about linux is that "we" have the ability to simultaneously

hack both sides of the network interface in order to transcend mob mentality by engineering tribal self-awareness..." Stig Hackvan

howard rheingold barcode

observation

"My friend Marc Smith, a sociologist-geek who works for Microsoft Research, has connected an inexpensive barcode scanner to a handheld computer with a wireless connection, and has installed code that connects the info returned from the universal product code database to the Google search engine. The UPC database provides salient information about the product linked to a bar code. It's all part of AURA, a research project to explore ubiquitous computing using off-the-shelf technology. People who register at the site can send their scans, and their comments on their scans, to a website. Their comments thus turn up within days, open to everyone with Google access, as results of keyword

searches relevant to the scanned object.

So what does that mean in practice? I went in his kitchen and scanned the first two objects I found. a box of prunes and a box of breakfast cereal. Then I googled the names of the products and the names of their vendors, as revealed by the barcodes. The first link to the prune growers, the Sun-Diamond Growers cooperative of California, was to a political polemic about "Bromide Barons attempting to undermine the democratic process with their financial influence." The "Corpwatch" was clearly a political group with an agenda. However, the second link revealed the syllabus of a Supreme Court decision against Sun-Diamond; the first line of the syllabus states: "Respondent trade association was charged with violating, inter alia, 18 U.S.C. § 201(c)(1)(A), which prohibits giving anything of value, to a present, past, or future public official, for or because of any official act performed or to be performed by such public official..."

Amazing! But perhaps an anomaly. The second item I scanned, however, was "Kellogg's Cracklin Oat Bran." The first entry in Google's list of links was headlined: "Kellogg USA Issues Allergy Alert on Undeclared Eggs, Milk, Soybeans, or Almonds in Kellogg's® Cracklin' Oat Bran® and Kellogg's® Smart Start® Cereals." Talk about your sentient things! As Marc says, "every thing has a story."

Labels on products reflect political decisions, often influenced by enormous economic forces. Witness the current battles over labelling foods that contain genetically-modified organisms.

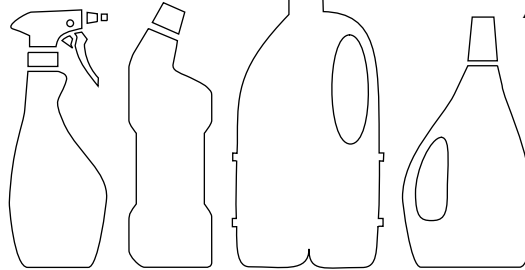

A product label is a closed system. The barcode, which links products to the machines that sort, track, and organize the distribution of the products, is connected to another closed system, the UPC database, which is open to public inspection but not public modification. However, when you apply Google searches to the information returned from the UPC database, the closed system is pried open by its connection to

a vast open system of documents, links, comments, and debates from public records, websites, and usenet postings. Citizens and consumers have been relatively powerless in regard to influencing the kind and amount of information revealed on product labels. A few off-the-shelf technologies, costing a few hundred dollars, some custom code, and a universally available web utility, threatens to upset this crucial balance of information-power.

"We are interested to study emergent individual and group behaviors associated with the ability to digital tag objects and places. In our system, a user can associate text, threaded conversations, audio, images, video or other data with a specific tag. Users can review the tags they have encountered and annotated in a custom web portal. Optionally, they can opt to have their comments be posted onto newsgroups. This allows search engines to index and essentially publish the association to other users. Physical annotations can be shared with other users and be rated by the users. reputation statistics. "

mapping companies

- installations, property (real and intellectual), assets
- inventory, logistical network, speed and flexibility of production
- finance

- personnel
- networks
- markets
- faith, trust, belief and other brand issues
- relationships with other companies

[etc]

governments, the media, investors and companies themselves, devote huge resources to mapping companies.

..new economy companies reduced the mapping problem considerably

- Idea “a flag in the sand”
- people “Give us your entire life or we won’t allow you to work on cool projects”
- funding “Broadly speaking, ideas can evolve to seem true or they can evolve to be true.”

corporations as robots

Corporations are created by humans to further the goal of making money. As Buckminster Fuller said in his brilliant essay The Grunch of Giants, “Corporations are neither physical nor metaphysical phenomena. They are socioeconomic ploys - legally enacted game-playing...”

Corporations are non-living, non-breathing, legal fictions. They feel no pain. They don’t need clean water to drink, fresh air to breathe, or healthy food to consume. They can live forever. They can’t be put in prison. They can change their identity or appearance in a day, change their citizenship in an hour, rip off parts of themselves and create entirely new entities. Some have compared corporations with robots, in that they are human creations that can outlive individual humans, performing their assigned tasks forever.

Isaac Asimov, when considering a world where robots had become as functional, intelligent, and more powerful than their human creators, posited three fundamental laws that would determine the behavior of such potentially dangerous human-made creations. His Three Laws of Robotics stipulated that non-living human creations must obey humans yet never behave in a way that would harm humans.

Asimov’s thinking wasn’t altogether original: Thomas Jefferson and James Madison beat him to it by about 200 years.

Jefferson and Madison proposed an 11th Amendment to the Constitution that would “ban monopolies in commerce,” making it illegal for corporations to own other corporations, banning them from giving money to politicians or trying to influence elections in any way, restricting corporations to a single business purpose, limiting the lifetime of a corporation to something roughly similar to that of productive humans (20 to 40 years back then), and requiring that the first purpose for which all corporations were created be “to serve the public good.”

The amendment didn’t pass because many argued it was unnecessary: Virtually all states already had such laws on the books from the founding of this nation until the Age of the Robber Barons.

..from a recent article by Thom Hartmann

community

community can be seen in the context of families, tribes, countries, federations of countries, continents, or a commonly held idea. Commercial, military and political units can be thought of as separate to or bound up with the communities they serve or are aligned to.

..what constitutes a community is a classification problem

classification

..evolutionary biology really began as a science concerned with classification from Aristotle’s legacy. What is so beautiful today, is that the whole thing is being turned on its head. All of a sudden, evolutionary biologists, particularly those concerned with more theoretical work, are questioning our ability to define, name, or classify even the most fundamental things. For example, there are at least a dozen different species concepts in use. Systematists [biologists concerned with classifying living organisms] cannot even agree on what a species is. And this is not because they are being limited or petty. It is because, knowing what we know about the world today, there is a philosophical problem with deciding where to draw species borders. You may disagree and argue that a lion is clearly different than a bobcat so that the argument must be purely theoretical. However, there are such practical concerns that come out of the species concept debate that it is impossible to dismiss it as a purely philosophical concern. The most important application of this work is in the area of conservation biology - where it is essential to come to some consensus about what is or is not actually unique and worth protecting. [This gets into a bunch of other things. One is about whether we should be protecting genetic or morphological diversity [a discussion that didn’t exist 50 years ago]. The other is about how we make sense of the fact that human and chimp genomes are only 5% different while identical looking salamander species have more than 14% divergence. I’ll spare you the details because I’m already rambling.]” There are a bunch of central dichotomies which evolutionary biologists are working through. I won’t give specific example for each now, but they give rise to very practical issues [in addition to the theoretical]. I list them for you just to illustrate that I think evolutionary biology can act as quite a bridge between technology and philosophy. Erica Rosenblum

[quote]

ORDER VS CHANGE : LOGICAL NECESSITY VS HISTORICAL CONTINGENCY : BEING VS BECOMING : HOLISM VS ATOMISM : FORM VS FUNCTION : STRUCTURALISM VS FUNCTIONALISM : EXTERNALISM VS INTERNALISM : HIEARCHY VS CONTINUITY : IDEALISM VS MATERIALISM : PATTERN VS PROCESS : ESSENTIALISM VS NOMANALISM

[end quote]

despatialised community

states are multiplying in the thaw

states that aren't states are multiplying in the thaw

cryptographically secure communities

Security and privacy through encryption should arguably be discussed in terms of a right rather than as a feature (hotmail etc. should be private and secure).

As borders and boundaries become a principal concern of real communities, so encryption is becoming a concern for networked communities. As mobile devices evolve to the point where they are by default broadcasting your location at any given moment, encryption becomes a clear synonym for security and privacy. Encryption will be a defining factor in the evolution of new forms of spatialised networked community.

actors

traditional community actors such as nation states, federations of states, politically aligned regions within nation states, companies, religious groups.. are being rapidly joined a range of new actors (and old actors reorganised to take advantage of new technologies and new ideas).

outsiders

degenerates can get you in and degenerates can get you out.

Free cities

"From the twelfth century on the feudal lords had been curbed and kept in place by the free cities."

a typical nomadic band consists of...

"the typical hunter/gatherer nomadic or semi- nomadic band consists of about 50 people. Within larger tribal societies the band-structure is fulfilled by clans within the tribe,"

dining clubs

"Pearl Andrews was right: the dinner party is already 'the seed of the new society taking shape within the shell of the old' (IWW Preamble). The sixties-style 'tribal gathering', the forest conclave of eco-saboteurs, the idyllic Beltane of the neo-pagans, anarchist conferences, gay faery circles...Harlem rent parties of the twenties, nightclubs, banquets, old-time libertarian picnics we should realize that all these are already 'liberated zones' of a sort, or at least potential TAZs. Whether open only to a few friends, like a dinner party, or to thousands of celebrants, like a Be-In, the party is always 'open' because it is not 'ordered'; it may be planned, but unless it 'happens' it's a failure." Hakim Bey

"values of a global community are bound to clash with local

values in various jurisdictions...regrettable, but the world is run by bozos..."

"The mandarins draw their power from the law; the people from the secret societies." -- Chinese saying

[secret societies in software]

Last winter I read a book on the Chinese Tongs (Primitive Revolutionaries of China: A Study of secret Societies in the Late Nineteenth Century, Fei-Ling Davis; Honolulu, 1971- 77): - maybe the first ever written by someone who wasn't a British Secret Service agent! - (in fact, she was a Chinese socialist who died young - this was her only book) - & for the first time I realized why I've always been attracted to the Tong: not just for the romanticism, the elegant decadent chinoiserie decor, as it were - but also for the form, the structure, the very essence of the thing.

Some time later in an excellent interview with William Burroughs in Homocore magazine I discovered that he too has become fascinated with Tongs & suggests the form as a perfect mode of organization for queers, particularly in this present era of shitheel moralism & hysteria. I'd agree, & extend the recommendation to all marginal groups, especially ones whose jouissance involves illegalism (potheads, sex heretics, insurrectionists) or extreme eccentricity (nudists, pagans, post-avant-garde artists, etc., etc.).

A Tong can perhaps be defined as a mutual benefit society for people with a common interest which is illegal or dangerously marginal - hence, the necessary secrecy. Many Chinese Tongs revolved around smuggling & tax-evasion, or clandestine self-control of certain trades (in opposition to State control), or insurrectionary political or religious aims (overthrow of the Manchus for example - several tongs collaborated with the Anarchists in the 1911 Revolution).

A common purpose of the tongs was to collect & invest membership dues & initiation fees in insurance funds for the indigent, unemployed, widows & orphans of deceased members, funeral expenses, etc. In an era like ours when the poor are caught between the cancerous Scylla of the insurance industry & the fast-evaporating Charybdis of welfare & public health services, this purpose of the Secret Society might well regain its appeal. (Masonic lodges were organized on this basis, as were the early & illegal trade unions & "chivalric orders" for laborers & artisans.)

Another universal purpose for such societies was of course conviviality, especially banqueting - but even this apparently innocuous pastime can acquire insurrectionary implications. In the various French revolutions, for example, dining clubs frequently took on the role of radical organizations when all other forms of public meeting were banned."

Hakim Bey

real communities brought together or sustained by the net

People find themselves bringing their network life into their real life.

conferences as temporary communities

conferences are a part of a lot of people's lives. They represent the artificial physical convergence of an often internationally dispersed group that share a common interest.

Conferences are slightly weird and dislocated. Kind of like they're not supposed to be happening.

They are a model for the idea of building your community around common interest rather than proximity or pre-existent relations and then managing to drag that community into the same room.

configurations [sets] of predictably populated temporary convergence

www.camcon.org

www.ted.com

www.biota.org

www.siggraph.org

hackers at the end of the universe

www.burningman.com

glastonbury

etcon

SRL

[..and banff banff gets interesting people together and funds fluorescent rabbits]

logistics

Logistics is the testing ground for the integration of the net with the physical world

once you click the 'buy' button, the thing you have bought has to get to you in the real world.

UPS

FEDEX

DHL

..and it is tracked all the way.

addressing

URL's and URI's

phone numbers

email addresses

web addresses

RFID tags

geouri tags

bar codes

zip codes and postal codes

geographical coordinates

addressing subjects things to the network

addressing changes the world

what the real world lacks at the moment is dynamic physical addresses

a fixed abstract address linked to the physical location of a thing or a person that changes when they move.

[pizza delivered to you as you walk down the street]

augmented logistics

the old logistics infrastructure in the broadest sense is being augmented by a combination of addressing, computers and networks.

trucks

cargo planes

container ships

freight trains

warehouses

[tracking]

soft architecture

new architecture

journey architecture

...Gilgamesh goes looking for immortality, Cupid and Psyche head off to get a box of Proserpines beauty, Aeneas goes off looking for his father, Orpheus goes off to get Euridyce...

new architecture

reality augmented

In real space, outside, people will soon find their worlds radically reinterpreted and augmented by a new generation of wireless networked location aware devices.

Location awareness will change the way people relate to the space, orientate them in that space, and help them find what they need.

It is now possible (and it will become progressively easier) to invisibly mark, demarcate and annotate real spaces. This makes possible a new architecture.

path and place

[EDGES]

J.G. Davies states that 'most buildings belong to either the category of path or that of a place, the one suggesting journey and movement, the other a centre and stillness ... between these two main categories there are structures that combine features of both: such are paths that lead to and include places, the latter acting as foci or nodes.'

[Lynch states] *'For a path to be identifiable, it must have strong edges; continuity; directionality; recognisable landmarks a sharp terminal; and end-from-end distinction.'*

Davies goes on to define place as 'a readily comprehensible shape' that possesses a discernable and 'concentrated' form with 'pronounced borders.' The place needs to be 'limited in size,' 'capable of being experienced as an inside in contrast to the surrounding exterior; largely non-directional' and to provide a 'focus for gathering'.

"all architecture is a structuring of space by means of a goal or path" Dagoburt Frey.

Norberg-Schulz also references Lynch and lists his own terms regarding path and place: "directions or paths", "centres or places" and "areas or domains"

Moreover, paths represent the willful leaving of one place and a journey to another

He cites the cosmogonic implications the path and place have held for ancient societies; the centre or place representing the centre of the world and the path leading away from this;

"the way is always directed from the known to the unknown."

"man is both centre bound and horizon bound" Aldo van Eyck

Thomas Barrie - 'spiritual path, sacred place' Shambhala

lost cat

I met Fiona Raby at the royal college of art ..she has this lost digital cat and if you go to the place where it got lost, it climbs into your phone and stays with you for a bit ..she also has this garden in your pocket which you have to physically go round helsinki finding plants with long latin names for ..and a table with a built in GPS and a display that reads 'lost' when it can't find itself

real space (outside versus inside) (augmenting reality vs simulating it)

So far computers have kept people indoors sitting in front of screens. The latest stage in computer evolution will see the next generation of kids running through the space with networked location aware computers [with short acronyms] strapped to them. These devices will make the space more interesting as they run, issuing instructions like Get to the end of the road and climb on the roof of the deserted cinema (for some unspecified future networked game related purpose).

Computer games that use and augment real space will probably result in a few deaths but at least it'll get kids out of the house and running around climbing things.

Augmentation is about to become a more interesting mass market problem than pure simulation. The market is orders of magnitude larger than the ghetto that is 3d gaming.

A range of new conceptual and design related problems are implied by augmenting real space.

Many of the more interesting augmentation problems relate to building new spaces and reinterpreting old ones.

Arguably these are problems for architects.

More likely they are problems for kids. If kids get their hands on these devices and prove receptive to them, then just by watching how they use them, it will become apparent what the devices are capable of and to what unforeseen uses that can be put.

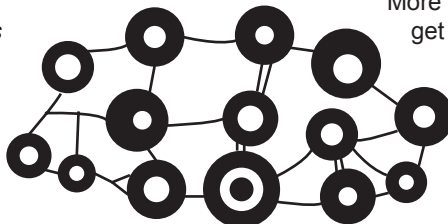

abstraction and empty space

A bald patch of grass on Wimbledon common may become important to some as yet non-existent community, and even as the community grows in size and importance, it may be unnecessary to build anything on that spot to emphasize its collective importance either to the community itself or to other communities.

Imagine if there were no billboards, no one wore bright colors or fashionable clothes, the buildings were all spartan and utilitarian, there were no street signs, none of the houses had numbers, and shops had no shopfronts just doors. The entire life of the culture not visible without some kind of technological augmentation. All colour and information was invisible to the naked eye.

city images

"There seems to be a public image of any given city which is the overlap of many individual images. Or perhaps there is a series of public images, each held by some significant number of citizens. Such group images are necessary if an individual is to operate successfully within his environment and to cooperate with his fellows. Each individual picture is unique, with some content that is rarely or never communicated, yet it approximates the

public image, which, in different environments, is more or less compelling, more or less embracing.

[...]

[mental maps of spaces]

the closer he looks, the more vague and smudged it all becomes

[...]

These environments are not only highly meaningful, but their image is a vivid one.

Certain holy areas may become very highly charged, so that there is a strong focusing of attention, a fine differentiation of parts, a high density of names. The Athenian Acropolis, saturated with a long cultural and religious history, was evidently named and parceled to the gods small area by small area, almost stone by stone, making renovations extremely difficult. The Emily Gap, a small gorge 100 yards long by 30 yards wide in the MacDonnell ranges of central Australia, is to the native people a veritable gallery of legendary locations. In Tikopia, the Marae, a sacred cleared space in the forest was used ritually only once a year. It was a small rectangle, yet contained over twenty locations with regular fixed names. Among more advanced Cultures an entire city may be holy, such as Meshed in Iran, or Lhasa in Tibet. These cities are full of names and memories, distinctive forms, and holy places.

[...]

there is a pleasant sense of familiarity or rightness in a recognised landscape. The Netsilik Eskimo put this well-worn idea in their own way: "to be surrounded by the smell of ones own things"

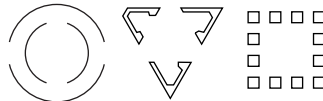

[...]

Indeed the very naming and distinguishing of the environment vivifies it, and thereby adds to the depth and poetry of the human experience.

[...]

[Florence] Progressive house numbering was introduced in 1808, and the city shifted over to reference by paths.

Kevin Lynch, *The image of the city*

aborigines

Aborigines, choose not to reshape the land in the ways that other cultures tend to, and instead rely on and interact with an incredibly complex internalised map of their environment, one that is extended through a shared oral tradition of mapping through song, the mapping having application to religious and spiritual practice, territorial boundaries, and practical requirements for food, water and shelter.

wayFinding

Field biologists are tagging and tracking all manner of species, mapping Monarch butterflies as they all head down to Mexico from Canada and then turn left to converge on a specific spot.

They speculate that whales are telling stories to the younger whales to help them as they migrate across vast stretches of ocean.

Analysis of dolphin communication based on techniques derived from information theory show that in dolphin dolphin interactions, the amount of information that can be or is being transferred, the bandwidth, is far higher than speech based human to human communication.

Whales and dolphins and chimpanzees don't expend enormous effort building houses and reshaping and marking their external environment

Having a sophisticated model of territory, physical and social, and using that model in a sophisticated way does not necessarily require you to mark or alter it.

Humans appear to be on the verge of transferring much of the information that they had previously physically engraved directly onto the environment, into a more abstract and invisible form.

If marking is a question of degree, then moving a large part of the information people have become accustomed to physically attaching to the space into portable devices represents a definite shift in the balance.

the discovery of culture in other animals

"If culture is defined by socially (as opposed to genetically) transmitted habits and knowledge, so that one group may develop quite different ways of doing things from another group of the same species, It is widespread indeed." Frans de Waal

brutus

Brutus was the leader of a community of eighty chimpanzees. Like other communities, parties of around ten would go off in search of food, often travelling in one direction for hours in silence. These travelling parties would keep in touch by pant-hooting and by drumming on trees with buttresses, which are very resonant and can be heard for thousands of metres through the forest. Boesch noticed that sometimes after he had heard drumming, all the parties in the community would change direction. Many months of patiently following the community made Boesch realize that it was only when Brutus was drumming that the community changed direction. Analysis of the drumming and the reactions to it led Boesch, a famously careful researcher, to the astonishing conclusion that Brutus was signalling to his community in a 'symbolic drumming code' based on the number of drumbeats. Brutus conveyed three completely specific messages:

1. Drumming once at two different trees indicated the direction he was proposing, which was the direction followed by Brutus when moving between the two drummed trees.
2. Drumming twice at the same tree meant rest for an hour. The community activity stopped for an average of 60 minutes. In twelve observed instances, the rest was never less than 55 minutes and never more than 65 minutes. Once Boesch observed Brutus drumming four times on the same tree, and the party

rested for 2 hours!

3. *Drumming once at one tree and twice on another tree meant change direction to the one proposed, and then rest for an hour.*'

For this form of communication to work, Brutus and other members must be able to use their numerical capacity to distinguish 1, 1 from 2 from 1, 2. This code is only found in this one community in the Tai Forest: it was part of their culture and no one else's. I say 'was' because Brutus has now stopped using the code. Poaching, the greatest threat to chimpanzee survival, has killed or kidnapped so many prime males that the number of travel parties has since declined dramatically.

the mathematical brain by Brian Butterworth, papermac 1999

the landscape serves as a vast mnemonic system (and plays a social role)

Way-finding is the original function of the environmental image, and the basis on which its emotional associations may have been founded. But the image is valuable not only in this immediate sense in which it acts as a map for the direction of movement; in a broader sense as a general frame of reference within which the individual can act, or to which he can attach his knowledge. In this way it is like a body of belief, or set of social customs: it is an organiser of facts and possibilities.

[...]

At other times, distinguishing and patterning the environment may be a basis for the ordering of knowledge. Rattray speaks with great admiration of the Ashanti medicine men who strove to know every plant, animal, and insect in their forests by name, and to understand the spiritual properties of each. They were able to "read" their forests as a complex and ever-unfolding document.

The landscape plays a social role as well. The named environment, familiar to all, furnishes material for common memories and symbols which bind the group together and allow them to communicate with one another. The landscape serves as a vast mnemonic system for the retention of group history and ideals

[...]

[Sapir] He goes on to note that the characteristic Indian vocabulary does not contain the English lumping-word, "weeds," but has separate terms for these sources of food and medicine, terms which for each species distinguish whether the specimen is raw or cooked, as well as its color and stage of growth: as in the English calf, cow, bull, veal, and beef.

Yung makes an interesting reference to a trained geologist who was able to march unhesitatingly through foggy alpine country, simply by recognition of the patterning of the geologic type of the exposed rocks.

Kevin Lynch, The image of the city

skateboard

skateboarders see urban environments with different eyes

[cf. Iain Borden - skateboarding, space and the city]

mental maps

People build complex internalised mental maps of the spaces they live in.

If a boy or a girl needs to get home late at night they have paths and places, boundaries and borders in their heads, relating not just to the bare facts of the space, but linked to other factors such as, what and where they consider safe.

So much of persons map of a space is influenced by, imposed cultural associations, territorial associations, what they need to get done, and past experience. The space itself serves to inform and trigger these associations intentionally or unintentionally.

If these individual internal maps could be formalised, externalised, shared and collectively extended..

..it would radically change the way people relate, both to the space around them and the people around them.

[mine human geography, anthropology, psychology and biology for these maps]

Tony Hiss in 'the experience of place' notes the inertia inherent in internal image of the external environment; the internal model only changes if we are aware that a change has occurred. It is now possible exists to digitally link these subjective maps and feedback changes to individual.

athens

"For a while city and citizen were one" Lewis Mumford. [Cited by Tony Hiss in 'the experience of place']

utopia (a)

"Utopia as a world by itself, divided into ideal commonwealths, with all its communities clustered into proud cities, aiming bravely at the good life"

utopia (b)

"Utopia has long been another name for the unreal and the impossible. We have set Utopia over against the world. As a matter of fact, it's our utopias that make the world tolerable to us: the cities and mansions that people dream of are those in which they finally live."

dreams shaping reality

Then I asked: "does a firm persuasion that a thing is so, make it so?" He replied: "All poets believe that it does, & in ages of imagination this firm persuasion removed mountains; but many are not capable of a persuasion of anything." William Blake

pilgrim

[MYTH]

Levi Strauss held that the underlying structure of myth was consistent [something that could be proved with diagrams...]

Architecture as built myth

The hero departs, passes through a number of trials, attains the goal or destination, and returns spiritually transformed.

[...]

the hero [pilgrim] retreats... "...from the world scene of secondary effects to those causal zones of the psyche where the difficulties really exist ... His second solemn task and deed therefore ... is to return then to us, transfigured, and teach the lesson he has learned of life renewed." Joseph Campbell

The hero's journey is characterised by the sequence of 'separation, initiation, and return,' in which the pilgrim experiences a rite of passage and emerges, in most cases, spiritually transformed.

According to Eliade, in traditional societies if a man or woman is to become 'complete', they must be born for a second time. 'Access to spiritual life always entails death to the profane condition, followed by a new birth.' Ones childlike self dies and one returns as an adult. Initiatory rites typically perform the function of a rite of passage from one mode of being to another.

"I want to depart from here today and achieve the deathless state"
[The Buddha leaves home]

..death and a journey to the underworld are a common mythological theme..

The rite of pilgrimage, analogous to the spiritual journey, is found in all the world's major religions. [an integral part of christianity, islam, Judaism, Buddhism, Taoism, and Hinduism]

The act of pilgrimage has always centred on the individual.

Richard Barber cites anthropological studies that suggest pilgrimage replaced initiation rites of traditional societies, of which preparation, separation, and return in a changed state are an essential part.

The goal [of the pilgrimage], the sacred place, through its architecture, often created a microcosm of the pilgrimage. An internalised world was created in which the pilgrim's journey is reenacted in the architectural setting ∅ the spiritual path and place.

Thomas Barrie - 'spiritual path, sacred place' Shambhala

cathedral theory

..religious architecture as a physical manifestation of a spiritual journey

wooden cathedrals

[stone cathedrals made of wood]

"First of all, wood was the foundation of its building.

All the elaborate masonry forms were dependent upon the work of the carpenter: it was not merely that the piers themselves, in the later gothic construction, resembled

tree trunks laced together

or that

the filtered light within the church had the dimness of the forest,

while the effect of the bright glass was like that of the blue sky or a sunset seen through the tracery of branches:

the fact is that none of this construction was possible without an elaborate falsework of wood: nor without wooden cranes and windlasses could the stones have been conveniently raised the necessary heights."

Lewis Mumford

ritual

[RITUAL]

The sacred place is a place apart, separated from the profane world

a place where God or gods are worshiped and rituals enacted.

Examples range from a simple clearing in the forest to complex architectural settings.

an 'axis mundi', a place where the three regions of the world ∅ heaven, earth, and the underworld ∅ were joined.

Consequently, it was a place where communication with God was possible, as we find in the dream of Jacob at Bethel, where there is a ladder ascending to heaven and the voice of the Lord offers prophecies. "How awesome this place!" says Jacob upon awakening. "This is none other than the house of God and this is the gate of heaven" (Gen. 18.17)

The path to the sacred place [...] often recreates the pilgrim's journey and its three components of preparation, separation and return. Typically, there is a delineation of entry, a place of decision as to whether to start the journey or not. This threshold also establishes what may be the first of many points of separation between the sacred and the profane, and generally involves some kind of ritualistic shedding of the outside world, as in ablution. The entrance gains access to the path or to an entire enclosed sacred precinct. Typically following the entrance, there is a sequence of defined spaces, places, or events along the path that grow increasingly more sacred, often including a number of choices. A spatial sequence provides a symbolic narrative as one travels along it and increasingly anticipates the arrival at and attainment of the sacred place.

The sacred place shares similar qualities, such as a clearly defined entry or threshold to the inner sanctum, which performs

functions similar to the entrance to the path. The sacred place itself is a clearly defined enclosure that has precise boundaries and is separated from the outside profane world.

"Public architecture at best aspires to be just this: a setting for the ritual that makes of each user, for a brief moment, a larger person than he or she is in daily life" Spiro Kostof

a symbolic narrative facilitated by the architectural setting

"a ritual is an enactment of myth" Joseph Campbell

Rituals also symbolises a return to promordial time or 'in illo tempore' the Golden Age, a time when the gods were present and the religious myths were initially enacted. Similar to sacred space, sacred time is perceived as an interval in the surrounding profane time."

The place took the form of increasingly enclosed and sacred places, culminating in the dense, dark, and small inner sanctum

Thomas Barrie - 'spiritual path, sacred place' Shambhala

synaesthesia through augmentation

Augmented senses combined with synaesthetic interfaces may mean you can see the phone ring or the temperature change.

simulation and augmentation

There are new companies that specialise in simulating real world physics on low-end platforms.

Made up primarily of postgraduate mathematicians and physicists rather than game hackers, they simulate rigid body dynamics, cloth, smoke and fluids. They can breathe life into the sterile jointed wireframe shapes that are produced by 3d modeling packages, making 3D game worlds more lifelike.

[Beyond this, in the longer term, physics models may help you judge the best moment to cross the road or make it harder to crash your car. Tomorrow's augmenting devices may well be 3d capable. 3d models of critical systems (like the engine of your car) may overlay your view of the real mechanism.]

A-life, AI and autonomous agent research is providing creatures of varying intelligence and behaviour to inhabit rich 3d space.

Current 3d capable game consoles, as well as the machines that Sony and Microsoft already plan to replace them with, are fast enough to simulate a very high level of realism and natural behaviour in real time.

Cheap high bandwidth internet connections, both wireless and cable, are now available to the consumer mass markets of Europe and America.

Even without these advances internet users have already become used to multi-user 3d gaming over networks.

People will inhabit rich and lifelike 3d environments in gaming and other contexts.

Companies have developed high-resolution retinal displays. These displays use lasers to project an image directly onto the retina. These devices overlay computer generated images onto real spaces. Retinal displays small enough to clip on to a pair of glasses will soon be mass market products.

All the creatures, tools and techniques of 3d gaming and simulation can find there way into the real space.

[You can already play quake in real spaces]

The future looks likely to see reality ever more accurately simulated, and that simulation looks likely to find a way into real life.

storytelling

Kris Griffith of Io research in san francisco and Fiona Raby at the RCA in London, are both architects who have found themselves designing interfaces for location aware devices. In separate conversations they both focused on the storytelling possibilities of location aware devices.

On one level storytelling is a good metaphor for thinking about both the way people move through space, and the capacity to influence their movements. On another more literal level, through location aware games, users can become characters in collective stories that unfold as people get close to one another, or move to and through particular spaces.

Location awareness also adds another dimension to the patchwork built up from surveillance camera footage, click history, credit card stubs, camcorder footage, phone conversations etc. ..you could tell the story of someones ordinary day using all this stuff

..spatial maps of films: where do the characters go? ..do they stay in a confined area or travel (linear or circular?)

dunne and raby

In san francisco and silicon valley hackers sit on roofs and in car parks and use wireless ethernet cards and laptops to find their way on to the wireless networks of companies close by. That this happens points out a kind of weird blindness by the companies to the spatial nature of their networks ..they are not thinking that these networks map spatially in a new way.

Fiona Raby and her partner Tony Dunne have worked on mapping electromagnetic fields onto space. The maps they create link directly to location awareness when this idea is applied to cell phone towers. The tower a cell phone is using at any given moment roughly indicates a users position in space. The coverage area of a tower is affected by factors such as distance from the tower and whether there are buildings between the tower and the user. The buildings create shadows which diminish coverage; so that in urban environments with a lot of buildings there is a far higher density of cell phone towers than in non-urban environments. The spatial footprint of a cell phone tower is different in urban and non-urban environments.

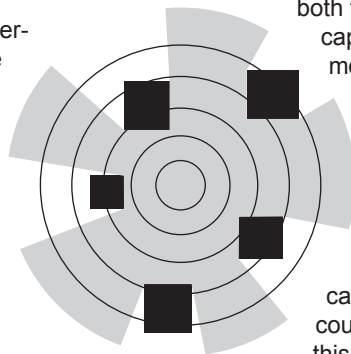

According to Raby people actually pull the cell they are using with them until another cell becomes sufficiently strong to take over ..this makes for beautiful fluid visualisations..

Kevin Lynch, *The image of the city*

artist engineering

“The artist of the late medieval period and the Renaissance was, also, the architect and engineer of his day and so necessarily mathematically inclined. Businessmen, secular priests, and ecclesiastical officials assigned all construction problems to the artist. He designed and built churches, hospitals, palaces, cloisters, bridges, fortresses, drawings of such engineering projects are in da Vinci’s notebooks and he, himself, in offering his services to Ludovico Sforza, ruler of Milan, promised to serve as an engineer, constructor of military works, and designer of war machines, as well as architect, sculptor and painter. The artist was even expected to solve problems involving the motion of canon balls in artillery fire, a task which in those times called for profound mathematical knowledge.” [lost the reference]

walk home

The balancing of the natural and the human-made, the forest and the path, the dark with the light, the compressed with the open, suggests the harmony that geomancy sought to attain. The path to the subtemple also describes a journey from yin to yang, the taoist principle so influential in Zen. The dark, earthy path through the forest yielding to the light, human-made environment of the dojo. Both elements were balanced, creating Harmonious environment ∅ earth balanced with sky.

Thomas Barrie - ‘spiritual path, sacred place’ Shambhala

magical associations can inhibit if they lack flexibility

The creation of the environmental image is a two-way process between observer and observed, What he sees is based on exterior form, but how he interprets and organizes this, and how he directs his attention, in its turn affects what he sees. The human organism is highly adaptable and flexible, and different groups may have widely different images of the same outer reality.

[...]

A landscape loaded with magical meanings may inhibit practical activities, The Arunta face death rather than move to a more favorable area. The ancestral grave-mounds in China occupy desperately needed arable land, and among the Maori some of the best landing-places are forbidden because of their mythical import. Exploitation is more easily accomplished where there is no sentiment about the land. Even conservative use of resources may be impaired where habitual orientation does not allow easy adaptation to new techniques and needs.

[...]

If it is desirable that an environment evoke rich, vivid images, it is also desirable that these images be communicable and adaptable to changing practical needs, and that there can develop new groupings, new meanings, new poetry. The objective might be an imageable environment which is at the same time open-ended.
[...]

storage and retrieval city

[Anthony Townsend, Taub Urban research center NYU] Townsend notes that cities are, in a sense, vast information storage and retrieval systems, in which different districts and neighbourhoods are organised by activity or social group. A mobile Internet device, he suggests, will thus become a convenient way to probe local information and services.

The Economist, Aug 9th 2001, Geography and the net - Putting it in its place

soft architectures

paths

points (foci)

boundaries and borders (traditional architecture)

enclosed spaces

annotation

the intersection of space and social networks

e.g. FOAF plus awareness of spatial proximity

coordination

competition

affinity

exchange

collaboration

finding

placing

moving

updating

mapping tracing paths

wifi nodes as local data collection points [starbucks deal?]

proximity

entering data

annotating (non-contact communication, hobo code)

marking (boundaries, borders and points)

mapping, imposing fantasy maps on real spaces

guiding, desk bound web user guides real person by cell phone

finding/placing real annotation: geocaching, chalk marks etc, geo-tag (it)

moving collaborative moving, getting stuff from A to B.

geocaching holographic cards

[betting]

placing digital objects

starbucks/wifi deal

go here pick up digital object [lost cat, garden in my pocket]

creating place feeds

aggregating place feeds (peer to peer subnets of place data)

detecting nodes (warchalking, noderunner)

conventional addressing post-codes, street addresses, cross streets

photos marked with GPS (via bluetooth)

inclusion and exclusion in a flexible mesh of separate social networks

headmap

andy at EA

nocat and consume

geowankers

RDF crowd and FOAF

backseat gaming

waag

playstudio pirates

supafly

blasttheory - uncleroyisallaroundyou

noderunner

rug mobs & spontaneous organisation

lost spaces

definition of architecture

“Architecture: from the Latin -teks - To weave (as a net); also to fabricate, a root shared with text, textile, context, subtle (“the finest thread of the weave”) and technology. More especially, to build a dwelling, with tools.”

American Heritage Dictionary

a new form of parasitic architecture (augmentation as)

Soft augmentation, the ability to annotate and bound real spaces without physically altering them, is a new variant form of parasitic architecture. A structure that is dependent upon and augments an existing structure can be classified as parasitic architecture.

optimism in architecture

Architecture is less and less about buildings, but can continue to be about our relationship to real space.

human beings are nomadic at a very fundamental level

the act of ritual is symbolised by path and goal

ebb and flow and local routing

A central idea in human culture is the journey. A journey is a fundamental way in which we relate to space. We move from one place to another in a linear sequence. The idea of the journey is central to our myths and stories, it is encoded in our architecture and implied in our built environment, the streets outside our houses, the paths through the woods, the networks of freeways, the railway tracks through our towns, the airports on the outskirts of every city, the ports distributed along every coast.

These paths serve a logistic purpose, to move people and to move things. We can choose to stay relatively still and things will find their way to our communities. But even this stasis still involves journeys; to work, to school, to shop, to the next room.

Novels are linear journeys, but even in a medium like the internet this linear idea persists, the way you experience hypertext is linear too, it just doesn't constrain the way you navigate.

Human beings have limited ability to multitask, at least at a conscious level (Distraction), so that each shift in our attention aggregated becomes a journey.

mnemonic architectures

“You are here - a virtual somewhere possessing an identifiable (interiorized) form and mnemonic associations by which you have arrived, will leave, and (may) navigate to return. Functionally similar mnemonic architectures have existed for almost two thousand years,”

Darrel Berry, The Poetics of Cyberspace

psychological projection (its not really there)

Architecture projects meaning onto space through physical restructuring of our environment.

What if the same principles could be applied without remodelling the space, if path could be implied without a sequence of real columns, a sacred space could be implied without a real perimeter.

sacred space

A place in a local park or an arbitrary piece of sidewalk could be become a meeting place or a sacred space with meaning overlaid but invisible.

a locus is a place easily grasped by the memory

"A locus is a place easily grasped by the memory, such as a house, an intercolumnar space, a corner, an arch or the like."

Darrel Berry, *The Poetics of Cyberspace*

the new world

"on the one hand he shared the practicality of the English school [...] on the other hand, he was imbued with the nonsense of hermetic philosophy."

A.L. Rowse on Elizabethan mathematician John Dee

voyages of discovery

"The opening of the 'new' world was conceived from the start as an occultist operation. The magus John Dee, spiritual advisor to Elizabeth I, seems to have invented the concept of 'magical imperialism' and infected an entire generation with it. Hakluyt and Raleigh fell under his spell, and Raleigh used his connections with the 'School of Night' a cabal of advanced thinkers, aristocrats, and adepts to further the causes of exploration, colonization and mapmaking. 'The Tempest' was a propaganda-piece for the new ideology, and the Roanoke Colony was its first showcase experiment."

Hakim Bey

voyages, navigation and the extension of knowledge

"there was a close and continuing dialectic between the voyages and the extension of knowledge."

A.L. Rowse

new worlds inspire hope and new ways of thinking

Virginia was conceived of along utopian lines

New worlds inspire hope and new ways of thinking. Voyages of discovery force advances in the technology required for such endeavours (navigation, map making etc.). If new worlds actually appear, there qualities, there character and evidence of there

existence affect the society which initiated the voyages, in intellectual and material ways.

The internet can be read as a new world and a new frontier, subject to reports from settlers, evidence of its existence (webvans etc.), land grabs and economic and social impact.

New ways of seeing the world can be analogous to new worlds.

'for a ship does not go into the seas of the opposite south without bringing back to the courts or academies evidence of those worlds.'

Vereenigde Oost-Indische Compagnie

memory maps and symbol systems (organising and structuring)

organising and structuring through externalised interior constructs

memory, symbol systems and architecture

most architectures exhibit both process and mnemonic aspects

"A mnemonic architecture facilitates memory and desire, a cluster which seeks to cluster. A process architecture provides access to tools. Most architectures exhibit both process and mnemonic aspects, either together, or in varying spatial and temporal aspects - this shelter from the rain, this arbour in which I dream."

Darrell Berry - *The Poetics of Cyberspace*

physical buildings function on many levels

Architecture is about utility, Corbusier contended that living spaces should be machines for living in.

Physical buildings function on many levels, and utility should be broadly defined: symbolic, narrative, mnemonic and aesthetic.

Buildings can be symbols of power, authority and permanence. Buildings prescribe journeys which you have to take in order to transition from one space to another. They can encode and reference ideas and function. They can be beautiful.

clay grahams symbolic arrays

"A church is an excellent example of this, a symbolic array is created where the interaction between the symbols in that array holds greater value than the essence of any one of the symbols within that matrix."

Clay Graham

a cathedral is a symbolic clearing in the woods

A cathedral is a symbolic clearing in the woods, sunlight through the tracery in the stained glass emulating light through branches. The columns are high and, like trees, arching up and spreading out. Ritual, symbolism, metaphor, mnemonic function converge in what were key medieval centers of power and administration.

using archetypes to convey the purpose of a space

Virtual Architecture uses archetypes to convey the purpose of the space. Archetypes are a low-level symbolic language, understood to be at the base of the human psyche, which the virtual architect uses to encode meaning. Ten archetypes are as follows:

AXIS: *Infers a path to a goal and begs to be followed.*

COURT: *The focus of action/inaction and cognitive awareness, a container of thresholds.*

RELATIONSHIP OF PATH AND PLACE: *The journey begins at the first threshold (initiation) and ends at the final threshold (enlightenment)*

PERIMETER OF DOMAIN: *The limit of understanding, the limit of the defined world.*

PORTAL: *A breach in the perimeter: the mouth of an axis connecting two domains.*

OPENNESS AND CLOSURE: *Defined by the perimeter, openness is the lack of understanding and closure is the comfortable area of knowledge.*

DATUM: *Spatial datum defines the scale and perimeter of the space; secondary datum may define items of interaction and is offset to show importance.*

COLUMN: *defines the perimeter and sets the vertical scale.*

WALL: *The primary method of defining the perimeter; also provides closure and clarifies breaches or portals.*

ROOF: *Preserves the relationship of sky and ground and provides the elevation boundary for the area of interactivity*

David Frerichs describes Clay Graham's archetypal paradigm

temporary architecture

Architecture serves to organise and focus all the appropriate symbols, meanings, and functionality that the proposed purpose of the building dictates.

Qualified architects are already finding themselves in many other roles aside from pure builders of buildings. Interface design, website design, building temporary structures for transient events like festivals, conferences and trade shows, 3d design for computer games and simulation.

As the networked world becomes increasing overlaid upon, and

integrated with, the real world, the new concept of augmented space will offer opportunities for redefining the boundaries of architecture.

Imagine if there were no billboards, no one wore bright colors or fashionable clothes, the buildings were all spartan and utilitarian, there were no street signs, none of the houses had numbers, and shops had no shopfronts just doors. The entire life of the culture not visible without some kind of technological augmentation. All colour and information was invisible to the naked eye.

Burning Man enforces a no money rule, no advertising, no spectators. When I was there in 1999, despite 25,000 people turning up, there were no concessions, no logos, no labels, no billboards. All the infrastructure and actual structures were temporary, including the airport and the 27 radio stations. The only food you had was what you hauled in from the outside or what you bartered for, and the only thing in the whole place you could buy was coffee or juice (carrot, apple and ginger). Weirdly enough this regime significantly and positively changed the atmosphere relative to analogous big gatherings. One guy came into a camp I was visiting and tried to exchange large amounts of drugs for a little food and something to drink, (an indication of value shifting in this artificial economy).

Symbol systems extend to the extreme utility of coherent addressing, the numbering of houses, the naming of streets, the boundary markers that define villages, towns and districts.

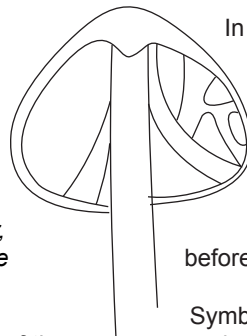

In Japan the streets are not numbered according to the western convention of beginning at the start of a block and increasing as you walk. They are numbered according to the age of the building, the oldest building is the first. So if someone gives you an address that just states the street name and number it is effectively useless. Cell phones are essential if you want to find your way to an address you haven't been to before.

Symbol systems can extend beyond conventional boundaries. symbols of approval and disapproval, support and opposition, descriptions of function and ritual attached to any arbitrary space, bespoke paths for individuals and communities parasitic on aggregated conventional common paths. Bespoke numbering and addressing systems.

The way the space is navigated, valued, and understood will change in the face of augmentation technologies.

the myths and rites constitute a mesocosm, a mediating, middle cosmos

"And if we now try to convey in a sentence the sense and meaning of all the myths and rituals that have sprung from this conception of a universal order, we may say that they are structuring agents, functioning to bring the human order into accord with the celestial. 'Thy will be done on earth, as it is in heaven.' The myths and rites constitute a mesocosm - a mediating, middle cosmos, through which the microcosm of the individual is brought into relation to the macrocosm of the all."

Joseph Campbell - The Masks of God

trees

"The tree is already the image of the world"

Deleuze and Guattari, 1000 Plateaus

tree of life

The tree of life, the Tarot, objects and symbols of power all find their way into common cultural currency, witness the masonic motif on the US dollar bill.

Religion and mythology are filled with old stories which can help articulate new visions.

Mythology, Archetypes and Religion are constantly mined by contemporary culture to encode, shed light on, and add authority to, new thoughts, new ways of thinking and new technologies.

[William Gibson used voodoo myth and symbolism mapped onto his dream of a networked world.]

Human culture is rich in this kind of symbolism and these kinds of dreams, they help to shape the internet already, everything is a metaphor for something in the real or mythological world, from daemons to trash cans.

Expect a new golden dawn.

'the symbol cluster of the Quest'

how religions work

"That's how religions work, a few people relate at first, the core of symbols then blossoms to incorporate new input." Clay Graham

visualisation should help people interpret information

A modern map is an abstraction, an understood convention.

A visualisation of any given data is only useful if you understand what is being represented and why. Without elaborate explanation a vector field is only really useful to someone who is used to vector fields. A three dimensional surface map is useless unless you are used to interpreting data in this form. Stock market analysts still prefer a sequence of bar graphs over three dimensional surface maps.

Visualisation should help people interpret information.

New languages, new conventions for abstraction, new kinds of visualisation integrated into our experience of space will change our conception of it.

the collective consciousness

"What did the backer hope to gain from it? A leased line to the collective unconscious" Neal Stephenson, The Diamond Age

culture

"every culture lives within its dream" Lewis Mumford

cultures give shape to worlds

Cultures give shape to worlds, through shared symbolism, convention and meaning.

Massively extended choice in a media context (Cable TV, video, internet access etc.) mean that the social homogeneity that followed from collectively experienced limited choice broadcast media is breaking down.

But we still all see the same street signs, the same billboards, the same line down the middle of the road.

The ability of a small community to affect the way its members see and experience the space in which they live will mean an end to a commonly held view of that space.

simulation and politics

"all simulation is political" Ted Nelson

scientific annotation

Science, like religion and mythology is a source of observations, classification and modelling leading to interpretation. But unlike religion and mythology it has use beyond communication through metaphor and shared meaning.

Science and rationality applied to an augmentation system, might literally mean describing, modelling, predicting and interpreting the world as we experience it. The collective body of scientific knowledge at your disposal. Plants and animals might be annotated and described, physical systems might be modelled with a view to prediction.

space as hierarchy of values replaced by space as a system of magnitudes

"space as a hierarchy of values was replaced by space as a system of magnitudes"

galileo

When people exclusively think associatively rather than in terms of a system of magnitudes, physics has a hard time advancing (cf. Galileo)

the ability to think rationally is pretty rare

Neal Stephenson wrote a book about a young girl growing up in a future dominated by nano technology called The Diamond Age. In it he described a 'book', an intelligent nano-computer that

functioned as a tutor to the girl, it could teach it's young reader all the concepts she needed to grasp, from the very simple to the very advanced, through a series of simulations and games, (e.g. escaping from a locked room in a castle requires working out the basic principles of a binary code).

cartesian systems plus emotion

Taking a rationally constructed system, and using it to further irrational, symbolic, non-utilitarian, human ends is always fun

augmenting reality

"Ritual is Mythology made alive." Joseph Cambell - The Masks of God

not so much a dwelling as a memory machine

"My little theater," Aglie said, "in the style of those renaissance fantasies where visual encyclopedias were laid out, syllogues of the universe. Not so much a dwelling as a memory machine. There is no image that, when combined with the others, does not embody a mystery of the world" Foucault's Pendulum - Umberto Eco page [283]

crenellations and slit windowed towers

"Behind crenellations & slit-windowed towers scholars & fedayeen wake in narrow monolithic cells. Star-maps, astrolabes, alembics & retorts, piles of open books and in a shaft of morning sunlight an unsheathed scimitar." Hakim Bey

lions and unicorns

"the leonine tradition and the wisdom of the unicorn"

externalising the internal

external representation of interior space

memory theatre

"What will we make of such spaces? Camillo sought to capture the entire scope of his world's knowledge within his memory theatre..." Darrel Berry - The Poetics of Cyberspace

syncretism

"syncretism: reconciliation or fusion of differing systems of belief, as in philosophy or religion, especially when success is partial or the result is heterogeneous."

apple and cabala

"I told them about a strange thing I had seen in Paris, a bookshop near quai Saint-Michel. It's symmetrical windows advertised it's own schizophrenia; on one side, books on computers and the electronics of the future; on the other, occult sciences. And it was the same inside: Apple and cabala." Foucault's Pendulum - Umberto Eco [page 255]

language

A hybrid of symbolism, ritual and rationality.

Push Singh at MIT was working on the assumption that language is heavily linked to spatial metaphor (ted supports bill, Tina is close to joe etc.) and consequently an artificial intelligence approach to language can be developed within the context of a physically accurate 3d environment, you can learn language in the human sense better if you inhabit a 3d space governed by the laws of physics.

the intuition of space

"It is the intuition of space which most fully reveals [the] interpenetration of sensuous and spiritual expression in language." Ernst Cassirer - The Philosophy of Symbolic Forms

evolution

Smash the symbols of the Empire in the name of nothing but the heart's longing for grace.

[...]

If rebellion proves impossible then at least a kind of clandestine spiritual jihad might be launched.

[...]

Evanescent incendiary mind-bombs, scary mandalas flaring up on smug suburban nights"

Hakim Bey

synaesthesia

seeing extraneous sounds while listening to loud music, hearing silent movement out of your field of vision.

commodification of synaesthesia.

lost spaces (better use of lost spaces)

Think of all spaces that are lost, the rooms, the places; where are the stories that could illuminate them and tell where they are.

rooms adrift

"...rooms adrift in foundering cities, room and streets, names like wounds, the room with windows looking onto other rooms with the same discolored wallpaper, where a man in shirtsleeves reads the news or a woman irons; the sunlit room whose only guest is the branches of a peach..." Octavio Paz, *Sunstone*

existence is everywhere

"Rimbaud said 'Existence is elsewhere', and Malevich once wrote, 'Only that which cannot be touched can be sacred'. To me, this experience of two places, two worlds, in one moment is a central form of the experience of modernity." Jeff Wall, *Introduction to Transparencies*

secede

to be an immortal you have to secede from the present

our time

"Our time calls for intelligent fads. Our time calls for a self-aware, highly temporary array of broad social experiments, whose effects are localized, non-lethal and reversible - yet transparent, and visible to all parties who might be persuaded to look."

The Internet is the natural test-bed for this fast-moving, fast-vanishing, start-up society."

Bruce Sterling - Manifesto jan 3 2000

land [implicit boundaries]

implicit boundaries

He described to me how on holiday with his wife and children he arrived at a popular beach early to find it empty. For no particular reason he used a bucket and spade to build a perimeter of sand castles 6 meters apart and 25 meters in diameter around his chosen spot. Through the course of the day, the beach filled up and yet no infringement of this unenforcable token boundary occurred.

a magical legal function

Soft augmentation, the ability to annotate space using location aware devices, will allow new concepts of land ownership and community and calls into question the geographical basis of power, politics and law.

a magical-legal function

the railroads, the steel plough, the six shooter, steel windmills and barbed wire

"the great plains were only subdued after 1865 with the aid of new technology: the railroads, the steel plough, the six shooter, the barbed-wire fence and modern steel windmills" Jared Diamond, *Guns germs and steel*.

parceling up land into rectangles

Before barbed wire it was difficult and expensive to define a perimeter and bound a large tract of land.

From the air Europe and America (both in urban and agricultural areas) are patchworks of rectangular bounded spaces; buildings and land.

change

"the 'nomadic war machine' conquers without being noticed" Hakim Bey

recolonise the usa ignoring old structures (overlay a new pattern)

A new layer of symbolism, a new way of defining ownership and meaning could be overlaid on the old. Invisible on the surface. New paths, new meeting places, new boundaries. New meaning associated with old structures.

Songs and voices and thoughts defining any given space.

Bums used to ride around the US on freight trains. They supplemented this logistical network with a symbol system that they could use to communicate useful information to one another. A given symbol scrawled in chalk might mean something like 'safe to sleep here'.

In san francisco you sometimes see a pair of shoes hanging from the tram wires. They either define territory or meeting places for local gangs.

Kids use graffiti to tag their territory.

Parasites on existing infrastructure.

Not removing or replacing what is there, but altering meaning. Redefining new terms, rules, language and symbolism.

parasite responsibility

Parasites powerful enough to absorb and dominate the old infrastructure without destroying it become colonists and define the hybrid entity.

Squatters in Zimbabwe are taking back land from British farmers, with the de facto support of the government. While the action is technically illegal the government is supporting the squatters and offering the British safe passage out of the country, rather than support.

The UK is now effectively another US state. [airbases, cultural and economic patterns etc.]

they colonise you back

“Anytime you colonise anybody they’re gonna eventually colonise you back.”

Erica Rosenblum

Flowlines

“At this moment in the evolution of the Web, and considering our demands for the “face-to-face” and the sensual, we must consider the Web primarily as a support system, capable of carrying information from one Temporary Autonomous Zone to another, of defending the Temporary Autonomous Zone, rendering it ‘invisible’ or giving it teeth, as the situation might demand. But more than that: If the Temporary Autonomous Zone is a nomad camp, then the Web helps provide the epics, songs, genealogies and legends of the tribe; it provides the secret caravan routes and raiding trails which make up the flowlines of tribal economy; it even contains some of the very roads they will follow, some of the very dreams they will experience as signs and portents.”

Hakim Bey, Temporary Autonomous Zone

open source language

pigeon, creole, slang, cant, argot.

[america effectively decided to open source and modify the English Language, it is now a part of one of the most pervasive and powerful operating systems on the planet.]

the question of land refuses to go away

“The despatialization of post-Industrial society provides some benefits (e.g. computer networking) but can also manifest as a form of oppression (homelessness, gentrification, architectural depersonalization, the erasure of Nature, etc.) The communes of the sixties tried to circumvent these forces but failed. The question of land refuses to go away. How can we separate the concept of space from the mechanisms of control? The territorial gangsters, the Nation/States, have hogged the entire map.”

Hakim Bey

athens

“Athens is neither a city nor a state, it is an idea” Aristotle

narrative has always been subservient to the tangible

Narrative has always been subservient to the tangible

Now economics and brute force may begin to favour narrative, in the form of network interpretations of old structures.

Distributed communities, built around ideas and new forms of association, will dominate the older forms seeking to contain and control them but bound to conventional ideas of proximity and control

‘it is not the land that must be conquered, but the hearts of men’

space Folding

before the telegraph..

If a thief robbed a bank and then boarded a train there was no way to inform the sheriff in the next town that a thief was on the train.

New York could not talk to San Francisco.

It was hard to know what was going on outside your local community.

Space dominated communities and communications.

[see ‘The Victorian Internet’ by Tom Standage]

escape valve

“With the occupation of the remaining open lands, this modern movement of population tapered off, and our mechanical civilisation lost one of its main safety valves.”

“Millions of people chose a lifetime of danger, ‘heroic toil’, deprivation and hardships, battling with the forces of Nature, rather than accept life on the terms that it was offered alike to the victorious and the vanquished in the new hives of industry.”

sleep late

“to be a tramp rather than lose his freedom to sleep as late as he liked, to eat what he could find at the time he wanted, to paint only when the passion to work took him.”

Anais Nin - The Chanchiquito

control

“rigid definition and control of land has been a central tenet of modern power structures.”

Hakim Bey

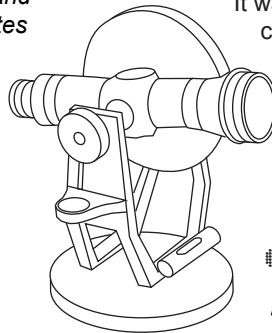

land as a central tenet of modern power structures

Control of land and freedom of movement are traditional measures of spatial power. Countries, borders, razor wire, checkpoints, property and prisons all reflect on how the space is subdivided and owned and how people are contained and controlled.

Borders are defined by historical conflict, political struggles, treaties and cartographers. Force of arms protects those borders.

The law (backed by force and political will) protects property rights within those borders and defines the way in which land is divided

The map is effectively closed, all land falls clearly under the jurisdiction and ownership of some state or other. There is no new world and no new frontier on the surface of the earth.

Augmenting and annotating reality will lead to a new conception of space, new ways of looking at land ownership, new kinds of communities and states.

Whole continents could be colonised over again without directly challenging the existing power structures, without people even being aware that it is happening.

civitas and urbs

“There is an old and useful distinction between the civic and the urban. Latin, as Fustel de Coulanges observed in his great work on the ancient city, distinguishes between the terms civitas and urbs. Families or tribes who joined together because they shared the same religious beliefs, social organization, form of government and modes of production created civitas - a community that was not necessarily related to any particular place or construction. But when such a unit chose a particular site and founded a city in which to dwell - as Rome was founded on the Seven Hills - an urban settlement resulted. So urban space became the territory of the civic formation, and civic principles determined the spatial configuration of the city. Choice of site, performance of the foundation ritual, and organization of the layout were seen as such fundamentally important acts that they were traditionally ascribed to the community's gods and mythic heroes.”

William Mitchell, *City of Bits*

nomadic

Communities based on symbolism, subsistence through acute local knowledge, and mobility.. [nomadic]

temporary autonomous zones

Hakim Bey wrote a paper entitled 'The Temporary Autonomous Zone'. It focuses on anarchist communities living in the gaps left by the dominant power in their domain. Assassins, pirates and the tongs. Communes, dining clubs and gatherings that serve as the anchor for all kinds of social groups and movements.

pirate networks

Pirate Utopias - The sea rovers and corsairs of the 18th century created an 'information network' that spanned the globe: primitive and devoted primarily to grim business, the net nevertheless functioned admirably. Scattered throughout the net were islands, remote hideouts where ships could be watered and provisioned, booty traded for luxuries and necessities. Some of these islands supported 'intentional communities', whole mini-societies living consciously outside the law and determined to keep it up, even if only for a short but merry life. [see texts like Daniel Defoe's history of the pirates]

[No more space, no terra incognita. Computer networks are providing gaps in which anarchist communities can find abstracted spaces that can anchor their efforts to live differently.]

The second generating force behind the TAZ springs from the historical development I call 'the closure of the map.' The last bit of Earth unclaimed by any nation-state was eaten up in 1899. Ours is the first century without terra incognita, without a frontier. Nationality is the highest principle of world governance not one speck of rock in the South Seas can be left open, not one remote valley, not even the Moon and planets. This is the apotheosis of 'territorial gangsterism.' Not one square inch of Earth goes unpoliced or untaxed...in theory.

occupy these areas clandestinely

from among the experiments of the inter-War period I'll concentrate instead on the madcap Republic of Fiume, which is much less well known, and was not meant to endure. Gabriele D'Annunzio, Decadent poet, artist, musician, aesthete, womanizer, pioneer daredevil aeronautist, black magician, genius and cad, emerged from World War I as a hero with a small army at his beck and command: the 'Arditi'. At a loss for adventure, he decided to capture the city of Fiume from Yugoslavia and give it to Italy. After a necromantic ceremony with his mistress in a cemetery in Venice he set out to conquer Fiume, and succeeded without any trouble to speak of. But Italy turned down his generous offer; the Prime Minister called him a fool. In a huff, D'Annunzio decided to declare independence and see how long he could get away with it. He and one of his anarchist friends wrote the Constitution, which declared music to be the central principle of the State. The Navy (made up of deserters and Milanese anarchist maritime unionists) named themselves the Uscochi, after the long-vanished pirates who once lived on local offshore islands and preyed on Venetian and Ottoman shipping. The modern Uscochi succeeded in some wild coups: several rich Italian merchant vessels suddenly gave the Republic a future: money in the coffers! Artists, bohemians, adventurers, anarchists (D'Annunzio corresponded with Malatesta), fugitives and Stateless refugees, homosexuals, military dandies (the uniform was black with pirate skull-&-crossbones later stolen by the SS), and crank reformers of every stripe (including Buddhists, Theosophists and Vedantists) began to show up at Fiume in droves. The party never stopped. Every morning D'Annunzio read poetry and manifestos from his balcony; every evening a concert, then fireworks. This made up the entire activity of the government. Eighteen months later, when the wine and money had run out and the Italian fleet finally showed up and lobbed a few shells at the Municipal Palace, no one had the energy to resist.

from Temporary Autonomous Zone by Hakim Bey

meaning trees

Many Europeans have spoken of the uniformity and featurelessness of the Australian landscape. The aborigines, however, see the landscape in a totally different way. Every feature of the landscape is known and has meaning - they then perceive differences which Europeans cannot see. These differences may be in terms of detail or in terms of a magical or invisible landscape, the symbolic space being even more varied than the perceived physical space. As one, example, every individual feature of Ayer's Rock is linked to a significant myth and the mythological beings who created it.

Every tree, every stain, hole and fissure has meaning.

Thus what to a European is all empty land may be full of noticeable differences to the aborigine and hence rich and complex.

Europeans may thus completely misunderstand the nature of the landscape because of their point of view.

Messages only become meaningful when received and recognised. Signals and signs become perceptual or conceptual meaning through symbols. Symbols thus change the biological and geographical world of signals and signs into a human world of meanings.

[...]

Underlying the visible landscape there seemed to be a symbolic landscape which was more real and of which aborigines had a clear notion.

What, therefore, needs to be considered is the relation of this symbolic world to the physical, the relation between symbolic and physical space.

[...]

By using natural features, the physical structure of landscape becomes congruent with mythical structure and hence humanised. If architecture is the mode of creating virtual space, making visible an ethnic domain and setting up a sphere of influence, then aborigines create place by giving meaning to sites in terms of their culture their ethnic domain. They do what architecture does in all the ways described but without the architecture.

To Europeans land meant buildings, crops, man-made artefacts, for aborigines it was a spiritual and emotional thing. Because aborigines did not cultivate land or erect permanent dwellings, that is because they took possession of land in non-material ways rather than in European terms, the latter did not realise that aborigines owned, occupied and used land. They could thus appropriate such land without qualms.

[...]

It thus seems clear that the Australian aborigines were most definitely able to establish a sense of place which was independent of any buildings which they might have constructed. This suggests that in the larger sense the establishment of place is a symbolic process. The use of physical barriers is only one way of achieving this - although, apparently, an essential one in our culture and context.

from Amos Rapoport - AUSTRALIAN ABORIGINES AND THE DEFINITION OF PLACE found in Shelter Sign and Symbol ed. Paul Oliver - Barrie and Jenkins 1975

the survey of india

There are insane maps of india covered in a dense mass of triangles.

George Everest

During the 19th century George Everest initiated a plan to formally survey, and then map, the whole of India.

mapping as conquest and control

Triangulation towers and theodolites became features of British India as far as the edges of the empire. Local communities came to see these towers as symbols of final subjugation and resisted violently, attacking and destroying them as they began to encroach on their territory.

maps (borders and boundaries)

Modern mapping provides a context for modern demarcation. The artificial idea of non-porous frontiers and nation states.

Arbitrary lines on maps.

Mapping is a mode of knowing and a method of controlling. [see texts like Ian Barrow's 'Moving Frontiers']

In a scientific context, observation, classification and modelling can be seen as a precursor to engineering, which equates to control.

The military has always been actively involved in map making, the Ordnance Survey in the UK is the primary source of civilian mapping data and is the primary governmental mapping organisation, until recently it was directly controlled and funded by the military.

During the gulf war, and in former Yugoslavia, the commanders integrated a whole range of spatial mapping technologies, from 3d terrain models to GPS, to enhance their formidable command and control systems.

uncharted territory

Uncharted land and water was always marked on a map as terra incognita.

Ancient and medieval writers mapped through narrative; unveiling and revealing the places they had been in associative rather than spatial terms, focusing on descriptions of places, people, and customs. They had more in common with the linear journeys of the songlines than spatial conception of Ptolemaic maps.

colonial cartography

"The first colonial cartographers of India were thus still surveying under the influence of medieval conceptions of the uncharted and its rhetorical practices of revelation. However, the maps drawn by James Rennell and his companion surveyors did introduce new attitudes towards the representation of land and frontiers, attitudes which, in the words of R.H. Phillimore, the Survey's historian, rescued the map "from the vagaries of fancy." David Harvey has remarked that the reintroduction of the Ptolemaic grid, with location determined by means of latitude and longitude, stripped maps of all their medieval "elements of fantasy and religious belief, as well as of any signs of the experiences involved in their production." Maps, now imbued with the principles of Enlightenment rationality, had become, according to Harvey, "abstract and strictly functional systems for the factual ordering of phenomena in space." While this essay will suggest that medieval spatial notions and cartographic practices together with contingency and contestation fashioned early colonial maps which were neither purely abstract nor functional, Harvey is correct to posit that maps displayed a greater 'objectivity'. Maps, as he says, lost much of their medieval sensuous, tactile character, and instead emphasized spatial organization and rationality. Nevertheless, how could maps rationally represent, in a coherent and systematic manner, anomalous revenue arrangements whereby, for example, the Company was permitted to demand revenue from certain tracts of land close to Bhutan from July to November only, at which time Bhutan once more claimed jurisdiction." Ian Barrow, 'Moving Frontiers'

bookmarking the oceans

..thinking about leaving notes in space, too much time spent thinking about urban spaces, and land in general. Some of the earliest adopters of civilian GPS were sailors and

just got to thinking about bookmarking the oceans

sure it already happens but an ocean would be a great thing to attach notes to..

..again notes beyond the utilitarian, thoughts, feelings, histories.

psycho logical geography

surplus futures

poverty as a relief (Knowing where the ground is)

"And there is another feeling that is a great consolation in poverty. I believe everyone who has been hard up has experienced it. It is a feeling of relief, almost of pleasure, at knowing yourself at last genuinely down and out. You have talked so often of going to the

dogs - and well, here are the dogs, and you have reached them, and you can stand it. It takes off a lot of anxiety"

George Orwell - Down and Out in London and Paris

heater

"frank bought a heater

an electric heater

with elements made of wire and clay

and he heard it say

c'mon and plug me in

plug me in."

Muttonbirds

honey

"you dead without money honey"

so much

"...So much corn, so much cloth, so much everything, that things will be practically without price. There will be no poverty. All work will be done by living machines. Everybody will be free from worry and liberated from degradation of labour. Everybody will live only to perfect himself." Karel Capek, (sp? Copek Corpek Carpek) Rossum's Universal Robots.

essential goods

"produce all essential goods in unparalleled quantities, falling on the just and the unjust, the foolish and the wise, like the rain itself"

[nanotech abundance]

[networked economy with niches for everyone]

"your hands shall flow with gold, but over you gold shall have no dominion"

poverty, wealth, satisfaction

"That life may be most intense and significant in its moments of pain and anguish, that it may be most savourless in its moments of repletion, that once the essential means of living are provided its intensities and ecstasies and states of equilibrium cannot be measured mathematically in any relation whatever to the quantity of goods consumed or the quantity of power exercised - in short, the commonplaces of experience to the lover, the adventurer, the parent, the artist, the philosopher, the scientist, the active worker of any sort - these commonplaces were excluded from the popular working creed of utilitarianism."

bee worker text??

leave your shoes at the door

'money is useful and poverty is boring and expensive'

'mad drunken bums wouldn't steal my shoes'

the fellow next door has enough money to switch on his heater when it gets cold. Six inches of wall divide us. Different worlds

this potentially not having anywhere to live thing is a real test of nerve

home

If home is as much about stable access to people, infrastructure and income as place, then we're rapidly approaching the point where home is anywhere.

I can sit here at this terminal in kathmandu and all I need is a pair of headphones and my stuff brought with me from home on a burnt CD. It's cooler than india and cheaper than london or california and the bookshops are functioning as libraries.

My friends at a distance, email holds the fabric of my distributed world together

You can find cheap access to the internet and consequently cheap international calls, email and a place to work, almost anywhere. It's easier in the third world than in a city like san francisco.

[pictures of kathmandu street kids]

what do you do when otherwise intelligent and beautiful people can end up living on the street, so close but so far from all the people walking past.

snakes and ladders

(we need more ladders)

A spatialised networked culture could supply more ladders

one general theory of america goes like this

In the UK on any given day, things can go a little bit wrong or a little bit right. The range of possibilities is fairly narrow. In America, on any given day, things can go catastrophically wrong or spectacularly right. If you can cope with this, or you have a choice, America is an interesting place to be, but the distance you can fall is far greater.

shopping trolleys

America is not a good place to fall off the edge of the world

a fierce lack of sympathy for those that don't make it

homelessness seems to be a disturbingly sustainable lifestyle.

san francisco

san francisco's homeless people wheel their worldly goods around in shopping trolleys

This has become such a motif that driving downtown one morning I found myself driving towards a huge billboard ad showing a shopping trolley tied up with ribbons with just married painted on the back.

People drift from all over the states to be homeless in san francisco.

new geography

new geography, new internet

The internet is about to overlay real space

For a while it seemed to stay the other side of the screen. No external evidence of its existence.

It has already escaped into the world. Like a bizarre genetic experiment that got free from a lab, evolving and self replicating uncontrollably.

The web addresses printed on everything.

Sometimes adverts have just an image and a web address, feeling almost like declarations of post-geographical independent statehood.

The next stage in its evolution looks likely to be augmentation.

Notes left on the internet attached to people and things and places that a new generation of devices will make available to you as you walk through the space and encounter those people, things and places.

Like a piece of acetate covered in rough notes and diagrams overlaying and annotating the original plan.

haircut

Walking into a leafy car park you see a wooden chair out of place. Lying next to it on the tarmac looking up at the sky is a girl. You walk over and point at your device and she gets to her feet and you sit down and she produces a pair of scissors and starts cutting your hair.

improvising in the new territory

"so many of our mechanical triumphs are merely stopgaps, to serve society whilst it learns to direct its social institutions, its biological conditions, and its personal aims more effectively."
Lewis Mumford

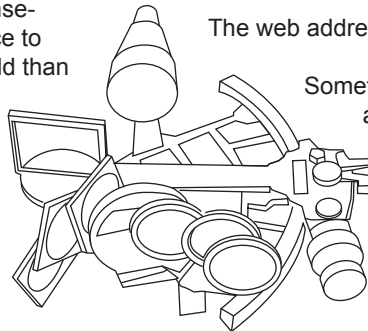

a cultural geography

Geographies of resistance are constituted by the transgression of ideological boundaries that are rooted in particular places and spaces

[...]

Places are active forces in the reproduction of norms, in the definition of appropriate practice

[...]

Power is the ability to make rules for others. The ability to define what constitutes appropriate behavior in a particular place is one fundamental form of this power

[...]

Transgressions disrupt the patterns and processes of normality and offend the subtle myths of consensus.

Tim Cresswell

plasticity of externalised meaning

location aware devices will reduce the importance of physically expressed symbolism bound to the built environment.

The discussion of this new plasticity of externalised meaning can be tied to ideas generated by the cultural analysis of architecture and geography (in a number of ways).

On the one hand, a study of an individual or collectively held internal model of a space can be used to inform the construction of externalised models and interfaces to spaces, on the other such analysis highlights the fact that to a large extent meaning is imposed invisibly already.

out of place

Even if new ways of invisibly annotating, marking and annotating spaces make new uses of space possible, using spaces in new ways is socially controversial.

It is possible to dispute the 'invisibility' of reality augmentation.

If invisible marking of spaces results in a change in who is using a space and (or) behaviour changes linked to the users of that space, then the marking of the space is indirectly visible.

If either the behaviour of the users of a space (or the users of the space themselves) appear out of place to whoever controls the space, there will be a perceived spatial and behavioural transgression.

Incongruous behaviour or perceived trespass by one group encroaching on the space of another is a potential source of conflict.

New kinds of transgressions inspired by a new generation of devices may lead to confrontation and conflict.

Even without visible alteration (e.g. graffiti) when collectively held ideas about a space are challenged, either by any kind of perceived usage change, or by a change in who is using the space, the controllers of a space are likely to feel threatened. Control in some sense means control over meaning and range of behaviours as well as ownership or the right to exclude.

landscapes have a biography and are authored.

Cultural landscape elements are markers that announce and display the presence of cultural group's most cherished ideals to its own members and to outsiders.

[...]

landscapes have a biography and are authored.

[...]

human ideas are expressed in behavior which then creates cultural landscapes. These landscapes, in turn, affect behaviour and ideas.

[...]

Space and place are key factors in the definition of deviance

Ingolf Vogeler

marigold

public space is used both to assert social norms and contest them.

The question is:

Who is the public space for? Who does the public space exclude? And how are these prohibitions maintained in practice?

Different people are designated different spaces by the people with the power to define boundaries.

Those who transgress the boundaries are made, by the people who control the space, into criminals.

People who are invisible or ignored by government often transgress their allocated boundaries, usually into public spaces, in order to be seen.

Here they become visible because they are not seen to be part of the 'public', their presence in public spaces is then contested.

Their transgressive movement is, in effect, seen as a criminal act.

The reason for criminalising their displacement is perhaps to diffuse or warn against other attempts to contest the hegemony.

The transgressive groups have moved onto a background that makes them stand out i.e., 'public' space, so that their dissatisfaction with the hegemony can be seen clearly.

They are then excluded publicly from the 'public' because they do

not behave according to the normative boundaries imposed by the government.

from Marigold

cultural geography Focused on resistance.

An analysis of a social space can take the form..

Who uses the space?

Who is excluded?

How are those prohibitions enforced?

What constitutes the meaning and range of 'acceptable' behaviour in a given space, as well as who is allowed to use a given space, are made more visible through transgressions.

Mobile phones have led to ordinary people openly talking to themselves in public spaces, this once suspect behaviour has been assimilated because of wide adoption and social acceptance of the 'legitimate' context of cell phone ownership.

It is an uncomfortable feeling if someone is reading from a retinal display while talking to you.

The inhabitants of Middletown still haven't entirely got used to their mostly naked hippy neighbours.

Why, given there relatively low cost and super-technical capabilities, is it unacceptable for homeless people to put up tents in urban spaces?

Fear geography

Public blame of victims who were in public places, for being in a dangerous or inappropriate place when they were attacked, encourages all women to transfer their threat appraisal from men to certain public spaces where they may encounter attackers. The other side of this fear of being in public space is for women to adopt false assumptions about their security when in places deemed safe for women, such as the home.

[...]

understanding of women's use of space necessitates an awareness of their geography of fear

[...]

Women develop individual mental maps of places where they fear assault as a product of their past experience of space and secondary information.

[...]

Informal social control in public areas relies on the potential intervention of others present to act as a deterrent.

[Valentine notes that this has been eroded by automation and spending cuts, which has led to a trend away from the informal moderation of spaces by people capable of intervention]

from 'the geography of women's fear' Gill Valentine

travellers and the rural idyll

"new age travellers, ravers and drugs racketeers arrived at a strength of two motorized army divisions, complete with several massed bands and, above all, a highly sophisticated command and signals system." [Conservative MP Michael Spicer speaking in the House of Commons] (Hansard, 1992a: 688)

"I don't think it should be a crime to want to live like that, to want to live in a rural area rather than a big city. And it's impossible to go out and rent a cottage or a farmhouse or buy one. Apart from people who are born to it, rural Britain is for the rich. It's for people who can afford to buy themselves a weekend place or go and retire in the country. For me, if I want to live with space around me and trees and hills and woods, the only possible way apart from sleeping out is to buy a vehicle and live in that." (Shannon, traveller, quoted in Lowe and Shaw, 1993:240)

[I]f the Government's proposals are enacted, the only people free to [adopt a nomadic existence] within the criminal law will be those wealthy enough to establish sites around the Country between which they may wander, as medieval monarchs were able to do. (Lord Irvine of Lairg, CJBC-L: 1194)

"The countryside is often considered to be a place where it is possible to put into practice another way of life." KH

"History has always dismissed the nomads" (Deleuze and Guattari, 1987: 394)

The nomad has a territory; - he [sic] follows customary paths; he goes from one point to another; he is not ignorant of points (water points, dwelling points, assembly points, etc.). But the question is what in nomad life is a principle and what is only a consequence. To begin with, although the points determine paths, they are strictly subordinated to the paths they determine, the reverse of what happens with the sedentary. The water point is reached only to be left behind; every point is a relay and exists only as a relay. A path is always between two points, but the in-between has taken on all the consistency and enjoys both an autonomy and a direction of its own ... sedentary space is striated, by walls, enclosures, and roads between enclosures, while nomad space is smooth, marked only by "traits" that are effaced and displaced by the trajectory" (Deleuze and Guattari, 1987: 380-81)

from Kieth Halfacree 'Travellers and the rural idyll'

patterns of spatial resistance

Cultural geographers have found patterns of spatial resistance that are common to graffiti, New age travellers, the homeless, raves, environmental and political protests and festivals.

Spaces are subject to group appropriation and control, and the act of using a space differently is often viewed as antagonistic. 20th century capitalism is founded on the ownership of property and the right to control the meaning and users of that property to the exclusion of others. It has been aided by the capacity to physically control the organisation and marking of real spaces. When the built environment and the meaning attached to a space become more plastic, and altering that meaning no longer implies directly marking or altering the space, how does that challenge the idea of

who owns (and who can own) the space and what it is for?

Mobile lifestyles consistently find themselves aided and encouraged by technological developments but in conflict with people trying to control spaces.

tramps

"The mobility of the tramp was resisted on a number of fronts ranging from the courtroom, to the academy to the popular press. Reactions to the tramp formed a classic moral panic in the years 1870 through to the second world war in the United States. Following the development of the first trans-continental railroad in 1869, migrant workers and those without work were suddenly able to travel the length and breadth of the continent in relatively short periods of time. The newspapers were full of advice on how to deal with the new tramp evil ranging from avoidance to poisoning to work camps. The tramp was represented as surely, lazy, politically radical and probably foreign." Encoding the mobile body: the production of the tramp, Tim Cresswell

diseases [plague syphilis]

insurrection

"It is the question of building which is at the root of social unrest today: architecture or revolution"

Increasingly public spaces are overtly and covertly designed to exclude.

[don't stop here]

[bum proof benches]

International travel [borders and boundaries] silk road, hippies getting enforced haircuts.

Nomads of various kinds, esther dyson, students, dj's, freeloaders

Tim Cresswell argues that Jack Kerouac used mobility to express resistance

just going (one american dream against another)

"The zigzagging of the plot is matched by the zigzagging of the language. It is important to note at this point that On the road was originally written as a 120 foot long continuous unpunctuated paragraph on a role of teletype. Kerouac reportedly wrote it in six days. It was only at the insistence of the editor that Kerouac introduced standard grammar and chapters so that the book could be published (nine years after it was written). Kerouac was attempting to create a nonstop statement of an experience that kept moving, using language with enough energy to break through the limitations of conventional notions of sentence form. Even in the edited version we can see this energy." Mobility as resistance: geographical reading of Kerouac's 'On the road' Tim Cresswell

Tim Cresswell argues that Jack Kerouac used mobility to express resistance

"Zelinsky (1973) described mobility as one of the defining

characteristics of 'American' character and how this characteristic was reflected in a landscape of highways and strip developments. My point is that mobility cannot be so simply 'mapped' on to the landscape. Mobility is also a deeply threatening and transgressive form of behaviour often described as 'deviant' (think of the threat in the term 'drifter'). The meaning of mobility in the United States (and in On the road) is therefore ambiguous at best." Mobility as resistance: geographical reading of Kerouac's 'On the road' Tim Cresswell

In on the road Kerouac sets one american dream against another.

Kerouac sets up an opposite to rootedness, family values and the 1950's hegemonic version of the american dream.

Kerouac subverts and contests and conjures up a vision allied to another aspect of the american dream 'the mobile male outlaws' [cowboys, indians, pioneers, hobos etc].

Dominant ideology in the United States places great emphasis on possession, including the possession of place. It is hard for us to question the value of ideas such as roots, community, home and neighbourhood.

When mobility is emphasized, on the other hand, it is as a means to get somewhere. Both social and spatial mobility are encouraged and connected as long as they result in 'improvement'. Mobility which is apparently purposeless and seems to result in poverty rather than 'social climbing' is not generally encouraged. This is reflected in geography. Migration studies purport to be about movement but use the push and pull factors of points A and B as explanations.

People leave point A because point B appears to be favourable. It is never the case that both point A and B are unbearable and that the motion in between is the 'pull' factor.

Negative views of mobility are expressed in the law. Vagrancy laws inspired Kerouac to write ironically:

'in America camping is considered a healthy sport for Boy Scouts but a crime for mature men who make it their vocation. Poverty is considered a virtue among the monks of civilized nations in America you spend a night in the caboose if you're caught short without your vagrancy change.' (Kerouac, 1960, p. 174);

[...]

Mobility represents a search for an American essence; haunted by the spirit of the outlaw, the hobo and the pioneer rather than the settlers, the farmers and the townspeople."

Mobility as resistance: geographical reading of Kerouac's 'On the road' Tim Cresswell

old people interfaces

see who i was

mall fortresses

fortress Architecture

stealth houses

gated communities

mall fortresses [‘the panopticon mall’] [surveillance cameras]

‘bum proof’ benches [benches that are round or too narrow so you can’t sleep on them]

armed response

Gehry accepted a commission to design a structure that was inherently ‘vandalproof’. The curiosity of course, is his rejection of the low profile, high-tech security systems that most architects subtly integrate in their blueprints. He chose instead a high-profile, low-tech approach that maximally foregrounds the security functions as motifs of the design. There is no dissimulation of function by form; quite the opposite, Gehry lets it all hang out. How playful or mordantly witty you find it depends on your existential position. [Frank Gehry’s Frances Howard Goldwyn Library. Los Angeles. USA]

‘City of Quartz’ by Mike Davis] [a study of modern mythology, architecture and social structure in Los Angeles]

acid steps

“have you been on the acid steps at kresge college at uc santa cruz? they were built so that large groups could not gather and stay standing. riot preventative.” Christi

campus defense

“often located far from centers of communal activities, many SUNY [state university of new york] campuses present the budding activist with formidable structural obstacles. Consequently, fewer and fewer members of the community attend campus events while issues of importance to the community rarely come to concern students encouraged to view their education in terms of vocational and professional training rather than the somewhat loftier vocabulary of the ‘liberal arts’ and ‘civic literacy’.” Soenke Zehle, Beyond campus boundaries.

situations

situationist international

The following fragments and quotes are from ‘Leaving the 20th Century. The incomplete work of the situationist international’ edited and translated by Christopher Gray. First published in 1974, and for a while the most complete set of situationists texts translated into English

leaving the twentieth century

I managed to obtain a last, dog-eared copy from a battered box found in a dusty corner of Compendium Bookshop, north London, in the winter of ‘79...

[from ‘Leaving the 20th Century. The incomplete work of the situationist international’ edited and translated by Christopher

Gray. First published in 1974]

the transformation of reality itself

Imagination should only be applied directly to the transformation of reality itself

Equally this transformation should not be in the hands of a small body of specialists but should be made by everyone. It was normal everyday life that should be made passionate

Everyone will live in his own cathedral: the situationists, 1958-1964 by Christopher Gray

[from ‘Leaving the 20th Century. The incomplete work of the situationist international’ edited and translated by Christopher Gray. First published in 1974]

modern Fiction

The modern artist does not paint, but creates directly..

Tristan Tzara

[from ‘Leaving the 20th Century. The incomplete work of the situationist international’ edited and translated by Christopher Gray. First published in 1974]

Formula For a new city

The situationists’ programme was based on what they called ‘the construction of situations’. In the first place this meant the bringing together and fusion of various separated art forms in the creation of a single, unified environment. Nor was this process restricted to a new focusing of contemporary artistic activity. All the great artistic Visions and masterpieces of the past should be pillaged and their contents made real: ‘subverted’, as the situationists called it, as part of a real script. All scientific knowledge and technical skill could be brought into play in the same way. For the first time, art and technology could become one: put on the same practical footing With reality. Working out the widest possible unified field of such ‘situations’ would reveal the true dynamic and shape of the city. Most utopian visionaries since Fourier paled before the situationists: ‘Everyone will live in their own cathedral. There will be rooms awakening more vivid fantasies than any drug. There will be houses where it will be impossible not to fall in love. Other houses will prove irresistibly attractive to the benighted traveller...’

(from ‘Formula for a new city’).

The point was the conjuring up and the mastery of immediate subjective experience. ‘Art need no longer be an account of past sensations. It can become the direct organisation of more highly-evolved sensations. It is a question of producing ourselves, not things that enslave us’ (from an article by Guy Debord in the same issue). Thus, the situationist project, as originally outlined, was the liberation of desire in the building of a new world - a world with

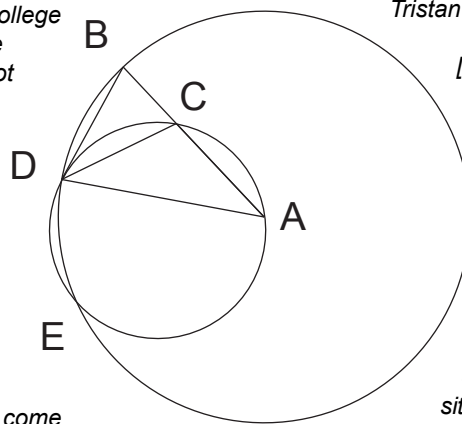

which we will be permanently in love.

This put them in much the same position as the first surrealists - and beyond Surrealism in the same position as a liberated psychoanalysis. Or, more simply, in exactly the same position as children. For their underlying philosophy was one of experiment and play - but play equipped with the whole of twentieth-century technology. Ultimately, all that was involved was the simplest thing in the world: wanting to make your dreams come true. And its enemies were equally simple: sterile, subjective fantasy on the one hand and, on the other, its objective counterpart: the world of art.

[from 'Leaving the 20th Century. The incomplete work of the situationist international' edited and translated by Christopher Gray. First published in 1974]

to play with time and space

Need for total creation has always been inseparable from the need to play with architecture: to play with time and space.

Chtcheglov

[from 'Leaving the 20th Century. The incomplete work of the situationist international' edited and translated by Christopher Gray. First published in 1974]

only in the possibilities

Only in the possibilities offered by the real distribution of time and space can all dreams become true and become one

[Chris Gray on Chtcheglov]

[from 'Leaving the 20th Century. The incomplete work of the situationist international' edited and translated by Christopher Gray. First published in 1974]

drifting and psychogeography

Before this, however, he was to play a leading role in developing the two main practical techniques used by the lettrists at this time: drifting and psychogeography. The first could be described as a sort of free association in terms of city space. The idea was simply to follow the streets, go down the alleys, through the doors, over the walls, up the trees and into the sunlight, etc, that one found most attractive; to wander, alone or with one's friends, following no plan but the solicitation of the architecture one encountered. Drifting was an attempt to orient oneself in the absence of any practical considerations: to find the types of architecture one desired unconsciously. Amongst other adventures, they found down by the Seine a door leading to what was supposed to be a small tool store, but was in fact a concealed entrance to those parts of the Paris catacombs that are closed to the public; apparently a large proportion of the total area. Hopefully, many happy hours were spent with the matches, the skulls and the rats.

'Psychogeography' was the study and correlation of the material obtained from drifting. It was used on the one hand to try and work out new emotional maps of existing areas and, on the other, to draw up plans for bodies of 'situations' to be interlocked in the new utopian cities themselves. During the same period they were also toying with new forms of communication and deconditioning

within the city. L'Internationale Lettriste were the first artists to understand the enormous potential of graffiti as a means of literary expression today. A number of the slogans they chalked or painted up - 'Never work', 'Free the passions', 'Let us live' - were to turn up again, more than twenty years later, on the walls of the Latin Quarter in May 1968. They also painted slogans down their trouser-legs and across their ties and shoes. The two latter items they tried to sell.

..photographs of girls, soldiers, bombings, comic-strip frames, maps of cities and diagrams of labyrinths, cathedrals and gardens

Their dominant intellectual concern was still With the fusion of all art forms in a new utopian town planning, while their experiments with architecture and the use of cities continued to provide a practical means of self-expression, a real group cohesion on the level of everyday life. Large-scale dnfts, sometimes using several teams linked by walkie-talkies, were undertaken; psychogeographic studies and architectural plans were worked out in detail. 'We are only at the beginning of urban civilisation... Twentieth century architects should be building adventures... (IS no. 3, 1959).'

What the SI in Paris was trying to work out was a new revolutionary critique of society: to discover forms of organisation and activity more effective than the slapstick anarchy of the lettrists. Henri Lefebvre had been their first mentor in social revolution. Once a leading French Communist Party theoretician, Lefebvre had resigned from the Party and become increasingly anarchistic. His basic contention was that contemporary society wasn't suffering from any shortage of consumer goods, but from a new poverty, a poverty of everyday life, and that revolution today must be focused on the regeneration of this area.

Used from the very first as a term to designate contemporary (French) culture, 'spectacle' was a spectacle, a circus, a show, an exhibition, a one-way transmission of experience. It was a form of 'communication' to which one side, the audience, can never reply; a culture based on the reduction of almost everyone to a state of abject non-creativity, of receptivity, passivity and isolation. Now they saw that the same structure applied not only to cultural and leisure 'activity', not only to political organisation (whether that of the ruling classes or that of the so-called 'left'). This experience of passivity, isolation and abstraction was the universal experience imposed by contemporary capitalism: an experience radiating from its basic alienation, the commodity. Henceforward, consumer capitalism was to be simply the 'society of the spectacle'.

The first thing this meant was that the situationists could no longer see themselves as an art movement of any sort at all. Art was no more than the consumer good par excellence. Any work of art, however radical, could be digested by modern capitalism and turned into the opposite of all it had meant to those who originally created it. From the point of view of Paris - increasingly that of Debord, whose intransigence was reinforced by the appearance of Raoul Vaneigem (born 1934) - all the other sections were dabbling far too much in 'experimental art' and courting the danger of being separated from what was essentially a total programme. Modern society wouldn't find any difficulty in reabsorbing individual works of art as the latest, chic revolutionary consumer item; and thus the rejection of consumer society made by the whole group would be compromised.

Everyone will live in his own cathedral: the situationists, 1958-1964 by Christopher Gray

[from 'Leaving the 20th Century. The incomplete work of the

situationist international" edited and translated by Christopher Gray. First published in 1974]

the new technologies of conditioning

A number of individuals were isolated in an environment designed so that nothing could happen (cells with bare walls, neon lights, the only furniture a comfortable couch and without any sounds, smells or variations in temperature). Extensive disturbances in behaviour resulted. The brain, in the complete absence of all sensory stimulation, falls below the Pitch of excitation necessary if it is to function normally. The Research Service concluded that a boring environment has destructive effects on human behaviour.

The struggle for control of the new technologies of conditioning

[from 'Leaving the 20th Century. The incomplete work of the situationist international" edited and translated by Christopher Gray. First published in 1974]

the construction of situations

The construction of situations can only begin to be effective as the concept of the spectacle begins to disintegrate. Clearly, the basic principle of the spectacle - nonintervention - is at the heart of all our alienated social life. And, equally clearly, all the most vital features of revolutionary experiment with culture have stemmed from an attempt to break the psychological identification of the spectator with the hero: to sting the spectator into action... Thus the situation is made to be lived by those who made it. The role played by a passive or merely bit-part playing 'public' must steadily diminish while that played by people who cannot be called actors, but rather, to coin a new word, 'livers', must equally steadily augment. Rapport sur la construction des situation.

[...]

"You could say the construction of situations will replace the theatre in the same

way that the construction of real life tends more and more to replace religion. Really, the main area we want to replace and fulfil is poetry - poetry which destroyed itself utterly at the beginning of the twentieth century.

[...]

The indignation of all the theorists of industrial design in the world won't do anything to change the fact that the private car is in the first place an idiotic game, and only secondarily a means of transport.

The construction of situations: an introduction

[from 'Leaving the 20th Century. The incomplete work of the situationist international" edited and translated by Christopher Gray. First published in 1974]

Formula For a new city

As a result, all contemporary art has been forced to become abstract contemporary architecture being the worst example of all. Pure plastic art, telling no story and making no movement, cold and soothing to the eye.

[...]

We want to create environments that are permanently evolving

[...]

The dark has been driven away by electricity and the seasons by central heating. Night and the summer have lost all their charm and the dawn has gone. Those who live in cities want to withdraw from cosmic reality and all they dream of is ways of doing so. For obvious reasons: dreams begin and end in reality.

Yet, contemporary technology could allow an unbroken contact between the individual and cosmic reality - minus some of whatever one considers its asperities. The stars and the rain can be seen through glass ceilings. The mobile house moves with the sun. Sliding walls allow vegetation to invade life. The house on metal tracks can go down to the sea in the morning and come back to the woods at night.

Architecture is the simplest way of articulating time and space; of modulating reality; of making people dream. I don't just mean expressing an ephemeral plastic beauty. Rather, a lasting influence, inscribed in the eternal graph of human desires and progress in realising them.

Thus, future architecture will be a means of modifying contemporary conceptions of time and space. It will be a means of knowledge and a means of action.

The architectural complex will be modifiable, either wholly or in part, by those living there.

Past societies offer an a priori truth and Ethics to the masses. The appearance of the concept of 'relativity' in a modern mind allows one to foresee something of an 'experimental' nature of the coming civilisation. Experimental isn't quite the right word. Say, more supple; more 'amused'. On the basis of this moving civilisation, architecture, at least initially, will be a tool for experimenting with the thousand different ways of modifying life - modifying it to the ends of a synthesis which will be more glorious a kingdom than anything the world has ever known.

A new form of mental illness has swept the planet: banalisation. Everyone is hypnotised by work and by comfort: by the garbage disposal unit, by the lift, by the bathroom, by the washing machine.

This state of affairs, born of a rebellion against the harshness of nature, has far overshoot its goal - the liberation of man from material cares - and become a life-destructive obsession. Young people everywhere have been allowed to choose between love and a garbage disposal unit. Everywhere they have chosen the garbage disposal unit. A totally different spiritual attitude has become essential - and it can only be brought into being by making our unconscious desires conscious and by creating entirely new ones. And by a massive propaganda campaign to publicise these desires.

We have already pointed out that desire to construct situations will be one of the main foundations of any new civilisation. This need for total creation has always been inseparable from the need to play with architecture: to play with time and space.

[...]

This new vision of time and space, which will be the theoretical basis of future constructions, is still imprecise and will remain so until there has been real, practical experimentation with possible patterns of behaviour in towns designed solely to this end: towns which, apart from the few buildings strictly necessary for some degree comfort and security, would consist solely buildings highly charged with emotionally evocative power, buildings one can feel, symbolical buildings representing desires, powers, events from the past, the present and the future. A rational extension of traditional religious experience, of myths, of fairy-tales and, above all, of psychoanalysis, 'into architectural expression' becomes more more urgent every day... as every reason for falling in love disappears.

Everyone will live in their own cathedral. There will be rooms awakening more vivid fantasies than any drug. There will be houses where it will be impossible not to fall in love. Other houses will prove irresistibly attractive to the benighted traveller...

[...]

...and an Astrolaire which would classify flora in terms of their response to the cosmic rhythms, an astrological garden like the one the astronomer Thomas wanted to build at Laaer in Vienna. Essential if consciousness of the universe is to be kept on the ball

Formula for a new city

[from 'Leaving the 20th Century. The incomplete work of the situationist international' edited and translated by Christopher Gray. First published in 1974]

unitary urbanism

Living criticism means the setting up of bases for an experimental life: the coming together of those who want to create their own lives in areas equipped to this end.

[...]

Pressure from situationist bases will, however, be exerted in the opposite direction: they will function as bridgeheads for an invasion of the whole of everyday life.

Unitary urbanism

[from 'Leaving the 20th Century. The incomplete work of the situationist international' edited and translated by Christopher Gray. First published in 1974]

not just the cops and the geometry

All space is occupied by the enemy. We are living under a permanent curfew. Not just the cops - the geometry.

[from 'Leaving the 20th Century. The incomplete work of the

situationist international" edited and translated by Christopher Gray. First published in 1974]

bear speech bubble

People who talk about revolution and class struggle without referring explicitly to everyday life, without understanding what is subversive about love and what is positive in the refusal of constraints, such people have a corpse in their mouth.

bear speech bubble

[from 'Leaving the 20th Century. The incomplete work of the situationist international' edited and translated by Christopher Gray. First published in 1974]

the boundless energy trapped under the surface of everyday life

The situationist destruction of contemporary conditioning is simultaneously the construction of situations. It is the liberation of the boundless energy trapped under the surface of everyday life.

[from 'Leaving the 20th Century. The incomplete work of the situationist international' edited and translated by Christopher Gray. First published in 1974]

an economy based on desire

'an economy based on desire.' This could be formulated as technological society plus the imagination to see what could be done with it. Moreover, contemporary economy is not based on needs, it is based on habits - habits that were never needs in the first place, but were quite blatantly manufactured by contemporary society.

IS no. 7. 1963

[from 'Leaving the 20th Century. The incomplete work of the situationist international' edited and translated by Christopher Gray. First published in 1974]

refuse for any reason whatsoever to return to earth

Space risks. Excluded. Article 3. A. No proceeds will be payable: In the event that the insured astronauts, under circumstances allowing them to survive in space, should deliberately and against the instructions of the National Aeronautics and Space Administration (NASA) refuse for any reason whatsoever to return to Earth.

[from 'Leaving the 20th Century. The incomplete work of the situationist international' edited and translated by Christopher Gray. First published in 1974]

lloyd george

You want to destroy our social organisation, what are you going to put in its place?

Lloyd George

[from 'Leaving the 20th Century. The incomplete work of the situationist international' edited and translated by Christopher Gray. First published in 1974]

de sade

De Sade analyses two possible attitudes.

On the one hand, the libertines of the 120 Days of Sodom who can only really enjoy themselves by torturing to death the object they have seduced (and what more fitting homage to a thing than to make it suffer?); or, on the other, the libertines of the 'Philosophy in the Boudoir', warm and playful, who do all they can to increase one another's Pleasure. The former are the feudal-type lords, Vibrant with hatred and revolt; the latter, the masters without slaves, discovering in one another only the reflection of their own pleasure.

Today, seduction tends to become increasingly sadistic. Sadism is inability to forgive the desired person for being an object. Truly seductive people, on the contrary, contain the fullness of desire in themselves; they refuse to play a part and owe their seductiveness to this refusal. In de Sade this would be Dolmance, Eugenie or Madame de Saint-Ange. This plenitude can only exist for the desired person if they can recognise their own will to live in the person who desires them. Real seduction seduces only by its honesty. And not everyone is worth seducing. This is what the 'Beguines' of Schweidnitz and their companions (thirteenth century) meant by saying that resistance to sexual advances was the sign of a crass spirit. The Brethren of the Free Spirit expressed the same idea: 'Anyone who knows the God inhabiting him carries his own Heaven in himself. By the same token, ignorance of one's own divinity really is a mortal sin. This is the meaning of the Hell which one carries with oneself in earthly life.'

Hell is the emptiness left by separation, the anguish of lovers lying side by side without being together. Non-communication is always like the collapse of a revolutionary movement. The will to death is installed where the will to life has disappeared.

From the Revolution of Everyday life, Raoul Vaneigem, 1967

[from 'Leaving the 20th Century. The incomplete work of the situationist international' edited and translated by Christopher Gray. First published in 1974]

they left

...But they were unable to prevent the steady encroachment of the various bureaucratic leftist sects and the endless verbalisation so beloved of students, so they left in disgust

Chris Gray

[from 'Leaving the 20th Century. The incomplete work of the

situationist international' edited and translated by Christopher Gray. First published in 1974]

mapping sex

spatial and social weirdness

Sexual relations are one way social relations actually do become concretized. Moreover, we tend to keep sex as contained as possible, and invent all kinds of boundaries to 'hold it in' such as monogamy, various legal injunctions, and the so-called common sense notion that sex is something we should keep to ourselves. Like a nation, sexuality has rituals and borders -- it even has exiles of various types. Since the idea of a 'nation' is one way we perform cognitive mapping, or a way we know who is 'with' us and 'against' us, it would seem logical that sexuality is another form of cognitive mapping. And indeed, we often use the sex act as a way of mapping ourselves in social space. Why else do we burn to know who is sleeping with whom at work, or among our friends? If you are engaged in conversation with a group of people you don't know very well, suddenly the social territory seems more familiar when you find out which people are having sex with each other. Or, on a different note, when you begin having sex with someone, your social landscape shifts dramatically. Their friends become your friends, and their social life is open to you because you have a definite place in it as 'the sex partner.' I have noticed, in the initial stages of a sexual relationship, the way my partner's friends and acquaintances will say to me, 'I'm sure I'll see you again.' When I am introduced to friends of friends, I rarely hear such a comment, even if it is likely to be true.

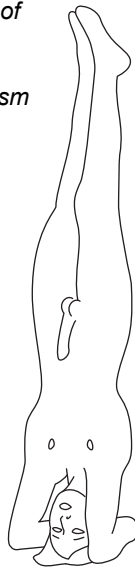

[...]

Sex is also a form of intimacy which is -- at least in its most common manifestations -- purely physical. This is what makes sex so literal -- and so frightening. What if you love somebody, but you do not have 'good' sex? Or, more frequently, what if you dislike somebody, but they know exactly what it takes to give you orgasms?

[...]

If sex is so wonderful and pleasurable, why don't we do it openly, and share it with everyone? The answer is connected directly to the way we tend to understand sex as an object, rather than an action based on thought and emotion. We use sex to quantify the value of particular relationships between people. Sex is a form of private property, which allows us to 'own' people or at least to figure out how much we own of them.

[...]

Through sex, I'm measuring something intangible: my connection to a particular person. For this reason, non-monogamy and public or group sex are fundamentally incompatible with the way we map sexuality today. Having been taught that 'ownership' and 'property' are concepts which limit access to particular objects, we regard sex as something which cannot circulate freely among people.

[...]

how can more than one person possess a single object at once?

Why Do You Want to Get Laid? Mapping Sexual Geographies

sexual geographies

The concern with regulative space and with the spaces of regulation develops Michel Foucault's project of discipline and sexuality - a field which was, arguably, his least overtly spatial. A recurrent theme running across a number of the articles is the ways in which sexuality in the city figures as a major site of cultural disturbance. Official geographies of immorality and obscenity have repeatedly been a focus for the attempted imposition of strategic order.

[...]

Frank Mort uncovers a more recent version of this double consciousness in the sexual geography of the Wolfenden report in the 1950s. The maps of London circulated by the doyens of Sir John Wolfenden's inquiry into homosexuality and prostitution provided the most detailed close-ups of the capital's sexual 'low life'. Despite the best efforts of Whitehall mandarins to define these immoral worlds as apocryphal and irregular, men from the metropolitan Élite continued to be personally and sexually dependent upon marginal spaces such as these. In all three cases, what is apparent is that the social geography of marginality frequently demonstrates a symbolic centrality. Transgression makes the norm meaningful.

[...]

What we might term a Foucaudian topography of the metropolis has been pivotal in all historical forms of strategic mapping. It would be instantly recognisable to the police commissioner, the magistrate or the sanitary engineer. Operating from on high, it mobilises a panoptic vision of the city and its subjects, who are viewed as part of a landscape and an aesthetics of discipline.

[...]

London's own characteristic ad hocery, for example, has generated its own recognisable sexual geography. The capital never experienced a police des moeurs, or moral police, on the Parisian model, nor have its zones of respectable and disreputable behaviour been as strategically zoned as in some other European or American cities.

[...]

Moreover, the capital's importance as the centre of empire, and latterly of post-colonial migration, has thrown up a series of extraordinarily complex spaces and cultures of sexual otherness, which have hybridised the city's existing populations time and again.

[...]

Insights of this kind problematise static topographies of the city. They also call into question a number of the taken-for-granted spatial divisions of urban society: between the public and the private, between masculine and feminine settings, between high and low cultures. What is apparent from all of these studies is not only the shifting and historically contingent nature of such geographical distinctions, but also the liminal spaces which have been produced at the interstices of divisions of this kind and the social actors who have generated more plural forms of spatiality.

New Formations, Sexual Geographies Editorial; Frank Mort and Lynda Nead discussing their joint work 'Sexual Geographies'

shoes

just watching her take off her shoes

g spot

Some female medical educators and researchers who have written about the clitoris and urethral sponge have been inspired to propose new ways of envisioning the female genitals. Instead of subscribing to the generally accepted model in which the clitoris and its shaft are described as a miniature penis, and the urethra, vagina and perineum are all viewed as separate unrelated bodies, they suggest instead that all these structures cohere as one functional unit that is homologous to the penis.

In her book 'Eve's Secrets', Josephine Lowndes Sevely proposes a model of female sexual response in which the clitoris, vagina and urethra are recognised as coordinated entity similar to the penis. Just as the entire penis is consisting of the two 'corpus cavernosa', the corpus spongiosum (the spongy tissue making up the glans and surrounding the urethra) and the urethra - is a unified structure, so are the female genitals. The structures that comprise the female genitals respond to sexual stimulation in concert."

The G-spot, by Cathy Winks, good vibrations, sf

SUN AND MOON MEDICINE

SUN MEDICINE / MOON MEDICINE

On the Poison Path we speak of sun medicine and moon medicine. And likewise then, there are sun doctors and moon doctors. For the Great Work neither can be neglected.

The sun doctor moves easily through the world, unperturbed, seemingly able to open doors anywhere she wishes. A life filled with routines and good health, with attendance to detail and reliability, the sun doctor knows where she stands.

The moon doctor has no need for ground. Realities scatter before him like tarot cards in the wind. He flies to the stars and has his way with the Queen of Heaven in her celestial palace. The moon doctor rides dragons and knows the way through hell. The sun doctor knows how to stay out of hell, and does. To the sun doctor every day is unique, every day happens for the first time. To the moon doctor there are no days. He lives in one instant only, eternally preparing the lunar medicine.

[...]

Some say that for the lunar master, solar medicine is unimportant. But not so. You need both of them, together.

In the absence of Sol, Luna thins

Pharmako/poeia - Plants, Posions and Herbcraft by Dale Pendell, mercury house san francisco 1995

angels

On the Seduction of Angels

Our Way is the seduction of angels. Trouble is, sometimes after you've seduced the angel, you find that it is really the angel that has seduced you. Then you find out that the angel has horns. Wonderful hard nubs of goatlike horn beneath her hair.

If you are a shaman of our way you don't care. In fact you are delighted. You love the horns. You kiss and fondle them. You weave intimate designs upon them. And are given woven charms in return.

Angels are hard to pin down. Ethereal. Their nature is movement. They are vectors, messengers.

Angels are between, and the between is of special interest to Hermeticists. One doctor of our way was visited at night by an angel who made love to her and then instructed her in the secrets of the preparation of the Great Stone. Rene Descartes was given the keys to mathematics.

Angels incarnate into plants and springs, into trees, into certain trails and grottos. When, they enter men or women we detect it by a subtle glow.

Walking into sleep secretly awake, into dreams without succumbing. Our way involves the will.

When the angel comes to your bed you might say no.

if you are sick, or poisoned, the angel can threaten you, might say, "Make love with me or I will kill you, I will make you sick. I will make you crazy. I will steal your soul and hide it where neither you nor the psychiatrists will ever find it." In such a circumstance it is best not to play the martyr.

Rituals invoke angels, especially sexual rituals. Threesomes, the minimal orgy. Or mere nudity

When she comes she is naked. The way she moves, the way she dances, it is as if she holds a knife, a chopper, and the things you thought were absolutely true and real reel and bleed

every angel is terrible..

Or maybe you have an opium ally. She is more than friendly. She'll call you up and invite you over. And she is voluptuous, so you go. She is so good to you it seems like heaven. You get what I mean.

Be ready to make deals. Try to get something for yourself

They never give anything for free. None of them do, not the most wholly and thoroughly benevolent, not the sun itself

Pharmako/poeia - Plants, Posions and Herbcraft by Dale Pendell, mercury house san francisco 1995

mapping Faith

"I'm curious to know

1. what it is that humans get from the act of faith specifically ..and

2. what faith looks like outside of a religious context

..the tendency towards transference of the deity role to the love object, and the inevitable failing of that fascinates me. I see it every day. I'm wondering into ways around that. Letting humans be humans, not forcing them to be gods that will ultimately disappoint and thus undermine entire belief systems."

Christi Sarkis

Faith is a placeholder

"faith is a placeholder -like a lipid- lighter than reality, and hard to lose"

C. Wareing

the wheel

approach dreams with sword drawn

I am absolutely convinced, as a Christian, that nothing is impure in itself only, if a man considers a particular thing impure, then to him it is impure. . . . What for you is a good thing must not become an occasion for slanderous talk; for the kingdom of God is not eating and drinking, but justice, peace, and joy, inspired by the Holy Spirit. Rom 14: 2-3, 13-14, 16-17

The Sanskrit for "poison" is visam.

In Buddhism, three poisons form the hub of the Wheel of Life:

kama-raga, "desire," or "greed," depicted as a red cock; a grasping quality: reaching out, to attain: meristematic. shoots after light, fungal hyphae seeking nourishment; or hanging on, grasping backwards, clinging.

dvesa, "hatred" or "aversion," a green snake;

and

moha, "ignorance", "folly", "delusion," represented as a black hog.

They chase each other and bite each other's tails.

Each poison is dependent on the others, and the whole cycle of birth and death is dependent upon them.

Pharmako/poeia - Plants, Posions and Herbcraft by Dale Pendell, mercury house san francisco 1995

maps

new ways of seeing (science as a sequence of maps)

Conventional maps represent new ways of seeing and interpreting the space. Maps linked to, and illustrating, statistical data and migration patterns, physical, political and climatic maps, all have utility in a relevant context, but also affect the way we think about what is mapped.

Science can be seen as a more abstract set of maps, opening up new territories for exploration

the whirlwind tour of modern mapping

"...just as those old atlases portrayed a world at once larger and startling and disquietingly different to citizens of the sixteenth century, a new atlas is aborning in the maps churned out by contemporary scientists; just as the world looks back to celebrate and ponder the quincennial feats of Columbus, science is making and mapping discoveries of entirely new and equally momentous geographies.

[...]

A whirlwind tour of the world captured by modern mapping extends from the atomic and microscopic to the cosmic. Planetary geologists have mapped the hills and dales of Venus by radar, Mars by magnetometer, Jupiter with photopolarimeters, the moon in person. Paleocologists have mapped the location of lakes that dotted the Sahara until disappearing four thousand years ago, and climate modellers are mapping the climate as it will appear one hundred years hence. From 590 miles up in space, satellites can determine the average income of a neighbourhood, follow wandering ice bergs, track wandering albatross; from instruments resting on the surface of the earth, physicists can see into the heart of the planet, into the heart of the atom, into the big bang. Astronomy's new telescopes chart the cosmos in all its multiple electromagnetic personalities: optical of course but also xray, gamma ray, infrared, radio, and ultraviolet. Biologists have mapped the location of proteins, electrons in atoms. Neurobiologists have mapped areas of the brain that light up when we dream. Where Aeneas may once have trod, the smouldering phlegrean fields now glow in aerial infrared maps. No earthly or celestial or even artistic territory has been spared this rampant cartography: experts not long ago scanned the Mona Lisa's sublime and mysterious face with a microdensitometer, measuring and mapping the topography of pigments in la gioconda's smile."

Stephen S. Hall - mapping the millennium

machines for generating interpretations

[a map] 'a machine for generating interpretations'

...a way to understand something else

If you can mathematically abstract the structure of a system you can usually map it onto many other systems.

Being able to Map an interpretation of one system onto other systems is why mathematicians, scientists and programmers often see themselves as basically lazy. Less work, more back.

a way of seeing the world differently

Human beings relate to the world through their technology. Technology defines your conception of space and the way you interact with and see the world (freeways, guns, barbed wire, desktop computers arbitrarily shape the world).

'If all you have is a hammer, everything looks like a nail'

A change in the technology that mediates your world changes the way of the world.

can be structured but it is never structured definitively

The way we see the world and conceive of space, the way we relate to, and interact with our local and extended communities will change.

generate different meanings

"And I would define the 'poetic effect' as the capacity that a text displays for continuing to generate different readings without being completely consumed"

Umberto Eco

songlines

"Song lines are the sound equivalents of the spacial [sic] journeys of the ancestors, the lines of which are found also inscribed in Aboriginal paintings and carvings. They detail the travels of the ancestors and each verse may be read in terms of the geographical features of the landscape. Encoded within them are the great ceremonies which reactivate the Dreamtime in the present." Mudrooroo, Aboriginal Mythology

aboriginal conception of space

The aboriginal concept of space clashed with western ideas of law and land ownership. Colonial settlers parcelled land up into neat rectangles enforcing these arbitrary boundaries with force and punishing trespassers.

A journey, and ritual associated with that journey were at the heart of the aboriginal understanding of their relationship to the land.

Footprints

Footprints, traces left that are transient, temporary and in isolation at the moment they occur. Aggregated, together, footprints can indicate a pattern, a direction and motive.

..evidence

footprints function as evidence of the presence of others

Robinson Crusoe

footprints don't just indicate existence and direction, they can imply action, condition, intent and motivation.

dogs

Dogs augment their environments. They piss on trees and leave their scent. Encoded information for other dogs. Kids tag their local environment. In both cases the message is fairly simple: I'm here.

trackers (information about those people)

Native trackers in Namibia, used by the South African army in the bush, were feared for their ability to discern and interpret every trace left by the guerillas they were sent to kill.

server logs

After an attack on a computer system is apparent, all the logs get searched for evidence of a hackers presence, and beyond that, methods used, origin and identity.

Logs kept by websites are used to track your behaviour on the web. These are reinforced by the cookies left on your machine when you visit a website. Companies (like Personify) build up profiles of your behaviour patterns (action, intent, motivation and condition) based on the traces you leave as you navigate the internet. Other companies (like Zero Knowledge) seek to protect your privacy while you surf and anonymous remailers like the now defunct anon.penet.fi (see galactus for information on anonymous email) seek to hide the trail email leaves (that leads back to you).

Your individual actions and choices are not as interesting as your patterns over time.

human beings as pattern

Following creatures

The army always seemed to me quite stupid.

It's traditional key features, uniforms, drill, marching, rank, endless exercises, applied to young men who were not necessarily incredibly bright.

As far as I can tell I'm a pattern following animal.

There are whole years of my life that I cannot clearly remember. Sometimes in an effort to recover those years, and in the absence of a journal or diary to remind me, I grab a pile of bank statement from that year and study them to see roughly where I was and what I was doing. Usually mind numbing patterns emerge. Same Safeway, same day, every two weeks, roughly the same amount spent. Same ATM every friday night roughly the same amount. Every two weeks a meal at one of a small number of revisited restaurants. Every month rent cheque, haircut, some aberrant item like clothing or travel. If I continue long enough the pattern

breaks up temporarily as I move to another city and then quickly settles down again. If I had my grocery receipts I'd find roughly the same food items recurring for months at a time. If I could trace my movements I'd find myself taking similar routes over and over again to get to the same set of destinations.

All of sudden the army isn't so stupid. They know I'm a pattern-based animal, that I like patterns and find it hard to break them once they are established. So they instill patterns for every conceivable situation that a soldier might face, so that when finally that situation occurs it is easier to follow the pattern than do anything else (like run away).

Then there is dependence on patterns like always having somewhere to sleep, always having a place to get food from, always having the same people with you, always doing the same tasks.

institutions

Sophistication, change and novelty, can cripple large institutions. Just clearly tell people what to do and let it be a subset of what they have always done otherwise nothing will ever actually get done. Institutions need to innovate with care, or with great violence.

A good startup company, begins agile and original, smashing the ingrained patterns of its competitors, when it reaches a certain stage of life it begins to congeal, patterns emerge and it becomes political and institutional. Smashing those patterns is possible but harder than starting again, hence the number, and success of startups in a time of accelerated change.

Venture capitalists, and the startups they fund, are the R&D department of corporate America. They take the risks and when something works it gets assimilated.

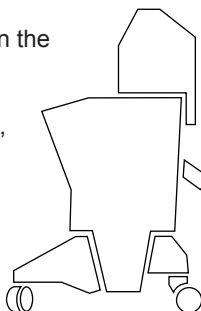

patterns in behaviour

For a while I used to keep a diary, diary entries were limited to a maximum of 10 words. An entry on a given day might look like this:

2. 3.96

climb.walk.work

sunlight.Carly.happy

The first five words were reserved for practical things, so if I worked, did nothing, wrote or coded I would use an appropriate word to represent that mental activity, if I did physical stuff like walking and climbing I'd enter whatever the activities were.

The second five words were more abstract. I'd try and think of keywords that would distill my feelings about the day (mood, people and sensations)

11.11.98

climb.swim.work"empty.bored.overcast

At night, before I wrote anything down, I'd lie in bed and try and retrace my steps during the course of the day. Establishing exactly where I had been, any interactions, and what I had done. Almost

a meditation ritual for sealing the day. When I had the day clear in my head, I'd distill the day down into a few practical words, and a few words that represented feelings.

[..in western culture this structuring used to fall into the category of prayer, going through your day at the end of it, considering your actions and your motives, but atheists have often discarded this practical tool, throwing babies out with bath water]

This distillation of a day down into a few words can function as a rigid form for a log. A haiku diary that, over time, builds up until patterns emerge.

Because of the concise and constrained form, it was easy to see the patterns. Patterns of productivity and inaction, of happiness, boredom and darkness, people recurring, appearing and disappearing, change of location (temporary and permanent).

A normal journal is too long to be read in this way. I always found that when I wrote a full page every day, and returned to it later, all I wanted was just an indication of mood, place, activity and people, and that it was hard to see patterns emerge over a longer time period, given that there was so much to read.

Another concept is the pure mood log, define a list of categories..

Boredom, fitness, health, how horny you feel, confidence, happiness, and then each day rate each of the categories on a scale from -5 to +5.

Then you can graph your mood and your 'state' over time.

Build a website that allows a group of people to do this. Aggregate moodlog entries within groups and determine group mood, plot the site graph and see if you could map mood to world events or local incidents.

Show people their patterns in a way that might be directly useful and interesting to them, even suggest changes in behaviour and be able to measure and show direct changes in mood resulting.

The extent of their effort would be 10 words or less a day for the diary, 10 numbers entered into the mood log a lot easier than keeping a conventional journal.

human patterns have become commoditised

"It was indeed the age of information, but information was not the precursor to knowledge, it was the tool of salesmen" Earl Shorris - A Nation of Salesmen

showing people there patterns rather than using them as sales tools

Market researchers have mutated into profilers of individuals.

Market researchers have long been keying their information geographically. One of the big digital mapping data companies GDT is a wholly owned subsidiary of a large market research firm, R.L. Polk (their tagline: 'multi-dimensional intelligence').

Zipcodes function as a means of subdividing the US for market research purposes, that is, they are a convenient topological convention for organising personal and property related data, a geographical axis.

Large chunks of the third world have no equivalent system (due to the lack of pressure from market researchers).

People could have their own patterns made available to them for non-commercial use.

extension of digital patterns and logs into physical space

The same mass tracking of behaviour that is evolving on the web, maps onto the behaviour of people and the movement of animals and objects in the real world. At the point when devices that travel with you everywhere are aware of their location, it becomes possible to track you in the real world.

sell your morning walk

If you are native to a city and a tourist asks you for directions to a place, you do not necessarily tell them the way you yourself would go, which might involve convoluted shortcuts and complications, you tell them the shortest clearly describable route.

Map the way people get from A to B, and establish that tourists travel one way, locals travel one way and commercial drivers yet another.

A tourist could access that information to get a different view of the city, finding out which way a local would go, or maybe a specific individual would go.

Mapquest finesse their routefinding capability using information from commercial drivers (making it difficult for a rival service to easily duplicate what they have with a pure static technology solution to routefinding).

You could sell your morning walk

..consider everyone selling their morning walk

Market research used to be labour intensive and data was expensive to gather. Now the job is being pushed out on to the internet and we all indirectly gather data, by navigating the internet and filling in forms, and buying stuff.

Beyond studying our habits as we sit in front of computer comes the point at which everything that is static in the world is mapped and everything that moves (vehicles, portable stuff, animals, people) is tagged, location aware and on the network.

Consider the patterns of migration and ebb and flow that might emerge when that data was harvested. The maps and the visualisations of that data. Beautiful, useful and terrifying (like any good technology).

The dark implications are similar to their web based counterparts, with an emphasis on spatial monitoring and control.

seti and solloway

Elliot Solloway builds educational software while working with underprivileged kids in the school system in Detroit.

His software offers young kids a chance to think like undergraduates. Complexities like modeling phenomena using differential equations are present, but hidden, using natural language scaffolding.

An example would be a piece of software for studying the local stream. You take a picture of your local stream and that image becomes the backdrop for the software, then, as a class, you begin to study it. You take measurements of all kinds. All this data is entered into the software, which becomes, over time, a model of the stream. At some point you begin to notice patterns emerging, you use your model to predict outcomes and suggest causal relationships.

Another example would be modelling weather. This gets interesting at the point where you get kids in schools all across the world submitting data in a common form over the web. Everyone begins to contribute to a more or less accurate model of the weather independent of professional meteorologists.

If the meteorologists make some suggestions as to what kinds of phenomena they need studied, an army of kids is now at their disposal generating data and learning as they do so.

Compare this to SETI (Search for Extra Terrestrial Life) a government funded project that had its budget cut dramatically. They leveraged what they had by building a distributed model for processing the data they were collecting. The team were able to release a screensaver that used spare computing cycles on any internet connected desktop to help with the number crunching.

Intel launched a screen saver that uses spare computing cycles to help cancer research.

Recently, according to Solloway, kids across America tracked the migration of a particular species of butterfly. The implication is that kids (and everyone else) can make big science and data gathering projects viable in the absence of huge grants. (see also the educational initiatives of the Digital Earth project).

rooms with histories

"I have a weakness for places - old battlefields, car-crash sites, houses where famous authors lived. Bygone passions should always have an address, it seems to me. Ideally, the world would be covered with plaques and markers listing the notable events that occurred at each particular spot. A sign on every pay phone would describe how a woman broke up with her fiancé here, how a young ballplayer learned that he had made the team. Unfortunately, the world itself is fluid and changes out from under us; the rocky islands Mark Twain was careful to avoid in the Mississippi are now stone outcroppings in a bean field. Meanwhile, our passions proliferate into illegibility, and the places they occur can't hold them. Eventually pay phones will become relics of an almost vanished landscape, and of a time when there were fewer of us and our stories were on an earlier page. Romantics like me will have to reimagine our passions as they are - unmoored to earth, like an infinitude of cell-phone messages flying through the atmosphere."

Ian Frazier, Jan/Feb 2000 issue of Mother Jones

transience and fragility

Transience and fragility are at the heart of internet killer apps.

Email - disposable notes.

Napster - a fragile temporary network where you might be able to find the mp3 you want due to the effects of scale.

The Web - no guarantee you will find the page or the site you visited today tomorrow.

ICQ - even more disposable notes.

a world filled with notes and objects that aren't really there.

"only that which cannot be touched can be sacred" Malevich

secede from the present

..invisible structures reinforcing ways of thinking beyond the conventions of your proximate peers and your community.

..secede from their present.

surface boy, surface girl

..a land with less to see, less on the surface, no visible signs, no colourful packaging

implicit rather than explicit

Aborigines can make the most exact and complex maps of the journeys of their ancestral figures and they themselves re-enact the journey going in procession from sacred spot to sacred spot, following the divine route. If we remember the processions in tracing the boundaries of Roman (and other) cities we find a similar way of defining place except that it was expressed concretely by building walls. In fact aboriginal areas where sacred objects are stored became sanctified and animals and people in them were safe - an early form of the city or house of refuge but without physical construction.

Aborigines do not move just in a landscape but in a humanised realm saturated with significations.

Aborigines structure their existing physical landscape mentally, mythically and symbolically without building it.

Amos Rapoport - AUSTRALIAN ABORIGINES AND THE DEFINITION OF PLACE found in Shelter Sign and Symbol ed. Paul Oliver - Barrie and Jenkins 1975

gps data streams (Eben Moglen and Immaterial Incorporated)

MOGLEN: Well, I don't think their answer is there's nothing we're going to be able to do about it. But the answer is we are no longer attempting to delay the adoption of strong encryption technology by United States export controls. You'll notice that last night they took the error out the GPS.

WORTHINGTON: So Iraq is now going to be able to target its cruise missiles precisely on top of the Washington Monument and not 50 meters away.

MOGLEN: Yes. The military says they will continue to provide wrong information in just those places that are absolutely important, but I don't think that means the White House or the Washington Monument. I think that means missile silos in Montana.

WORTHINGTON: Do you think, ten years from now, we'll see maps published showing the version of the United States that's being released now, with these abrupt transitions from crystal clarity to fog?

MOGLEN: Mapmaking is a very interesting subject in general, because when everybody in the country is carrying GPS equipment, one kind of mapmaking that will be absolutely possible consists of the whole structure of what we think of as free data. That is to say - people voluntarily walking around with GPS equipped cell phones donating the stream of their information to a mapping database which will be a very accurate map of everywhere all the time. Every bridge, every road, every place in the country will be repeatedly measured by people moving around with GPS equipment.

WORTHINGTON: Have you heard of any project like this today?

MOGLEN: I'm not aware of any. But you can see that it will happen, because that data stream will exist, and there will be a kind of decentralized geographic information service structure, but I don't think anybody has yet thought about what will happen. You have lots of people thinking about it from a commercial point of view - Pizza Hut guys wondering how soon they'll be able to advertise to you on your cell phone where the closest Pizza Hut is.

from the 'Immaterial Incorporated' transcript of an interview with Eben Moglen: *The Encryption Wars, Part I.*

no guarantee of liberatory use of tech

"The banalization of TV, the yuppification of computers & the militarization of Space suggest that these technologies in themselves provide no "determined" guarantee of their liberatory use."

Hakim Bey

liberation and destruction

New technology, before it arrives, heralds destruction or liberation depending on whose account you happen to be reading. The internet has been (all at once) an anarchists tool, a military tool, a tool for salesmen and businesses, and in general a communications medium for everyone able to use it for whatever purpose they intend.

social control (police sensorium)

"But this is hardly the ultimate police sensorium. As gang hysteria and the war on crack keep the city's coffers open to police funding requests, it is likely the LAPD will continue to win political support for ambitious capital investment programs in new technology. Having brought policing up to the levels of the Vietnam War and early NASA, it is almost inevitable that the LAPD, and other advanced police force, will try to acquire the technology of the Electronic Battlefield and even Star Wars. We are at the threshold of the universal electronic tagging of property and people - both criminal and non-criminal (small children, for example) - monitored by both cellular and centralized surveillances. Of the latter, ex-Los Angeles police chief, and now state senator, Ed Davis (Republican - Valencia) has proposed the use of a geosynclinal space satellite to counter pandemic car theft in the region. Electronic alarm systems, already tested in New England, would alert police if a properly tagged car was stolen; satellite monitoring would extend coverage over Los Angeles's vast metropolitan area. Once in orbit, of course, the role of a law enforcement satellite would grow to encompass other forms of surveillance and control." page 253

"As part of it's "astro" program LAPD helicopters maintain an average nineteen-hour-per-day vigil over 'high crime areas', tactically coordinated to patrol car forces, and exceeding even the British Army's surveillance of Belfast. To facilitate ground-air synchronization, thousands of residential rooftops have been painted with identifying street numbers, transforming the aerial view of the city into a huge police grid." page 252

City of Quartz - Mike Davis

weatherman one

"The man coordinating these many teams in various global locations is codenamed Weatherman One. The Weatherman has the ability to 'consider huge amounts of data and to make quick, calm decisions' helped along by 'cybernetic implants which link his cerebral cortex directly to the SkyWatch computer net'"

From Captain America to Wolverine - Mark Oehlert

commercial satellite imaging

swedish space media network

French SPOT system of

commercial satellite imaging

to customer spec. [+ USA LANDSAT]

been placed between Americans and life.”

Earl Shorris

magic(k)al tech

magic(K)al tech definition

‘magickal technology’ defined as tools that allow individuals and groups to generate, impose and reinforce alternative realities and ways of seeing.

magickal technology manifests in diverse ways; consumer electronics, buildings and the environment, habits of mind and social norms, conventions relating to the body..

..Location aware devices (LADS) represent a significant development in the evolution of magickal technology.

[read the headmap manifesto and headmap localis(z)ation for more on the implications of location aware devices]

hyp(t)nosis

Milton Erickson, the hypnotherapy guru made it clear that even under hypnosis it’s very difficult to force someone to do something against their will. However it is possible through suggestion to lead them where you want them to go. The power of suggestion means is possible to get people to do things by generating an imagined environment and context in which the choice you want them to make is implicit. For example it’s much easier to suggest to someone they get naked on a nudist beach than in a library. The trance state that accompanies hypnotherapy allows internal manipulation of context and environment to create an implicit suggestion (rather than having to manipulate the external environment)

..everyday environments suggestively coercive

Mind control then is a less serious problem than having your mind directed. Any environment can be created to imply an action or a thought.

Community and the built environment are both structured in such a way that your choices are infinite but the ones that are favoured by the architects of the community or the environment are easy, unconstrained and manifest.

People usually recognise and choose from (and accept) the obvious choices (Microsoft Word is infinitely configurable to suit the users preference, but the majority of users never change the default settings, the French resistance was a minority faction during the nazi occupation)

This is only sinister if the implied choices and action go against your interests, or the interests of others.

[numerous weather satellites]

NYTimes 30th Jan 1989

Scientific American 264 No.1(Jan91)

soviets enter commercial satellite business

down to 5 ft resolution from

SPOTs French 10 ft i.e. military grade

American response to question

their own policy of total secrecy.

[real-time multispectral imaging]

popular culture and technology to keep people grinning mindlessly (virgin)

“To complain about the society of the spectacle as a contemporary social disease is to forget that it was the Romans who declared that all the people wanted in order to be contented was bread and circuses, or pizza and television, if you prefer.” Marcos Novak

social control through information

People will almost certainly use location aware devices without strong privacy protection in place, as long as transactions are secure and there is no overt discernable violation. If it makes their lives easier Americans seem content to have huge market research firms keeping data on them and selling that data.

This is an argument for strong encryption, impartial automated infomediaries, and a non-proprietary distributed open source infrastructure.

If this technology impacts without privacy built-in, all kinds of organisations could not only know your internet browsing habits, but where and when you go (in real time - i.e. where are you now), what you buy and who you see, and from that establish the patterns in your spatial behaviour. A step beyond being able to sell your bank statement.

If all our experience becomes mediated by technology how do we stop salesmen getting access to our every waking moment irrespective of place and time?

a salesman had been placed between americans and life

“reality did not cease to exist, of course, but much of what people understood as reality, including virtually all of the commercial world, was mediated by television, it was as if a salesman had

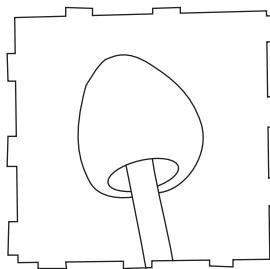

empirical limitations and enhancing the senses

The human mind does not perceive, and never has perceived, 'reality' to its ultimate extent. Perceptual tests reveal that the human mind derives its impression of so-called 'reality' through an astonishingly narrow and data-poor series of quick retinal impressions. This very limited visual tracking - commonly only ten to fifteen percent of our environment is ever subjected to a direct flow by the eyeball - is assembled into a seamless perception of reality by the optic centre of the brain (assisted by neural-net subprocessing in the retina and optic nerve). These human organic, wet-ware visual processors like all processors, could be 'hacked'.

Beyond judgement - this is in some sense the last revelation. The entire ontological structure of Cartesian doubt has been rendered irrelevant by neural-implant science. The fundamental cosmic constants of life and thought can now be directly engineered. Philosophy's despotism with its predilection for Platonic-fascist top-down solutions is subverted. With the capacity to enhance the effect, our physical command over the means of perception and cognition are complete. Here wet chemical and dry computer digital engineering converge.

disinformation 'strange days (virtual spaces) by Adrian Gargett, Ph.D

trance, suggestion, set and setting

Hypnosis then is two things, gnosis (a trance state) and suggestion (based in a non-material, pliable context and environment).

Set and setting are words taken from the language surrounding the use of psychedelic drugs, your trip will go, not just well or badly, but in particular directions, largely based on your state of mind (set), your environment and who you are with (setting).

the original captain trips

Whereas many LSD practitioners were content to strap their patients onto a 3' x 6' cot and have them attempt to perform a battery of mathematical formulae with a head full of LSD, Hubbard believed in a comfortable couch and throw pillows. He also employed icons and symbols to send the experience into a variety of different directions: someone uptight may be asked to look at a photo of a glacier, which would soon melt into blissful relaxation; a person seeking the spiritual would be directed to a picture of Jesus, and enter into a one-on-one relationship with the Savior.

'the original captain trips' by Todd Brendan Fahey

build your way out

Set and setting are the basis of suggestion. Suggestion is just as powerful in ordinary states as it is in trance states.

Even in the absence of a trance state or hallucinogenic drugs, set and setting are all pervasive and powerful in shaping human communities and constructs for good and for bad.

For the most part set and setting have remained only partially in the control of individuals, the built environment, especially in cities is something externally determined and subject to incredible inertia, buildings tend not to be moved very often and replacements take a long time to build when they are.

The power of set and setting extends beyond choices to implied processes and actions. Kids find themselves at school surrounded by other kids, teachers and text books, and are implicitly bound to the patterns this reality dictates. Schools are usually/often there for the benefit of the kids (this thought is adjustable depending on the school, the teachers and how paranoid you are) but the implicit coercive artifice is real none the less. The same is true of the world of work, military and monastic life, occult sects and revolutionary movements, and these are just the explicit and overtly contrived cases. Arbitrary realities designed to imply ways of doing things (and who you should listen to) that usually do not originate from the individual. Even in the absence of contrivance and design, accidental or de facto structures can still imply a narrower range of actions.

Milton Erickson implies that it in terms of suggestion it is arbitrary whether the constructed environment and context for making a suggestion viable and attractive are internally visualised in a trance or externally realised as a real physically apprehensible situation. Physical and mental structures and processes indivisible.

[someone pointed out that the best way to get someone to rob a bank was not to hypnotise them but to tell them, in an appropriate setting, that it was part of a carefully controlled psychology experiment]

The liberating aspect of all this is that if you have the means to create your own set and setting you can make structures that implicitly support you in your efforts to get wherever you want to go and narrow down (or open up) your range of choices to get you closer to the choices you want to make. The capacity to alter the external environment can be limited in the absence of sufficient money or power. But music, art and graffiti, warehouse parties, raves and music festivals, camcorders, desktop publishing, drugs, fashion, groups and scenes have all served to give people a way to inexpensively and spontaneously overlay an alternative vision onto contexts and environments (sets and settings) they do not directly control.

It also implies that control over your environment is not something to be surrendered lightly or blindly.

It is a good where possible idea to practice on a small scale constructing your own built environment. Organising warehouse parties, building your own house or temporary shelter are actually ways to take control of your own mind.

During the early seventies the hippies, realising that they were going to have to build themselves free of social conventions, spent a good deal of energy focused on building communes, homes and shelters without recourse to architects or conventional forms [see the book Shelter edited by Lloyd Khan and the Whole Earth Catalog's]

magickal tenets

A new generation of pragmatic occultists made very clear a view of magick which is usable whether you allow action at a distance or restrict yourself to psychology.

They assert that belief in itself can manifest worlds that you cannot access without it.

It is a central tenet of occult systems of magick that belief and belief systems change the shape of reality.

the placebo effect works if the patient believes the drug being taken will be effective.

mathematics and science are magickal technologies that have conjured many different worlds during their evolution

consider the many different geometries that have arisen since Euclid or the quantum and newtonian realities which currently co-exist but which manifest different worlds

Mathematics was always on the occult magickal curriculum

and despite criticism of mathematics engineering and science for over focusing on the material world, the reality is that both activities manifest incredible internal worlds and the real world manifestation for a long time remained incidental (archimedes considered engineering and science a distraction from the pure abstraction)

..that is control over the internal world is in some sense control over the external world

the meta belief that belief is a tool

You are the totality of what you do and can therefore change yourself by doing otherwise. Magic is the art of deliberately believing and pretending very hard and finding that it works. Highly improbable things can be done by those who are prepared to experiment with the belief that they are not quite so improbable. The world is an illusion, it has played a confidence trick on you if you let it define who you are. However, you are able to play confidence tricks on the universe and force it to accept your own definition of yourself(s). In fact, the universe, being a humorous, obliging and magical structure, will invariably collude in any such definitions you care to make, if you act skillfully. We are all charlatans, especially those persons pretending to be normal ordinary people....

[...]

..accept the meta-belief that belief is a tool for achieving effects; it is not an end in itself.

Peter Carroll [From 'Chaoism and Chaos Magic', Chaos International, issue 10; p. 11.]

magicians dealing in abstractions

Interestingly many modern (occult) magickians have tried to strip away a lot of traditional occult dogma and do not require you to sign up for satan or buddha, they argue that the tarot and the i ching work on the same principal of externalising the psyche, so choose either or make up your own equivalent, they say dedicate your rituals to whoever you want because the process is more important. .

Magicians may not care about which gods they pray to, but they do care about the abstractions, the foundations, and about magickal technology; they want a science of set and setting.

..empiricism

Whether there is a real world is a difficult question, but whether there is or isn't, the world we experience is an internal construct derived from sense data. Consequently the difference between the real and the imagined is at least at some level arbitrary.

brain valve

To make biological survival possible, Mind at Large has to be funneled through the reducing valve of the brain and nervous system. What comes out at the other end is a measly trickle of the kind of consciousness which will help us to stay alive on the surface of this Particular planet.

[...]

Aldous Huxley, The Doors of Perception

the brain valve and the ego filter

In 'the doors of perception' Huxley argued that what we perceive normally is a filtered version of what are perceiving.

Carlos Castenada talks in terms of shifting the parameters of this filter (the assemblage point) to create new subjective realities.

some heuristic assumptions about consciousness:

- what the conscious mind is aware of is a filtered subset of what is actually perceivable and / or perceived
- the parameters of that filter can be changed effectively creating a new world

Huxley argued that hallucinogens were a 'pipeline to Mind at Large by-passing the brain valve and ego-filter'

further assumptions

- the unconscious mind maintains the rules / map of the world and the conscious mind is subject to those rules and the constraints of the map
- gnosis / trance states allow constructive / manipulative interaction with the unconscious mind
- unconscious / conscious split treated as equivalent to world / self split

Acting on the self (conscious mind) then has limited effectiveness compared to changing the world (unconscious mind) which constrains the self

magick, soft forms hard forms

Acting on and interacting with the world [unconscious] rather than the self [conscious] is the focus of many esoteric practices (e.g. magick, meditation) but it is also the subject of serious study among psychologists and medical researchers (e.g. hypnotherapy, placebo)

It is possible to effectively talk about acting on the world / unconscious from two divergent points of view

There is a spectrum with action at a distance and the group mind at one end (magick) and psychology/psychotherapy at the other

soft forms - hypnotherapy placebo

hard forms - action at a distance, group mind, aether

esoteric energy [useful model or independent and interdependent link between people]

other planes [states of consciousness or places separate and shared by others]

contriving and internalising intent and belief [changing the self or changing the universe]

ritually externalising the psyche [working on the self or group mind / aether]

telepathy [information theory or group mind / aether]

the step between soft forms of these ideas and hard forms is small in language terms but fraught in intellectual terms.

that step is bound up with abandoning conventional attempts at material explanations in favour of some unverifiable process that allows action at a distance.

At which point you allow astral travel to be actual rather than symbolic (in the sense of the representational accuracy of what is seen, rather than a material reality). You allow spells to affect the material/aetherial universe rather than being a method for instilling intent into yourself. The individual psyche becomes joined to the collective psyche, such that actions within can cause change without, again so that symbolism gives way to a real networked larger or distributed consciousness.

telepathy becomes independent of information theory arguments about line of sight and infinite amounts of information fitting through the slightest connection.

energy and chakras cease to be ways of describing and become systems aligned to higher consciousness that allow occult martial applications as well as higher communication and healing

Tarot cards become not just tools for externalising the psyche, but genuine divination tools

the interesting thing is that the step doesn't have to be taken to make the ideas useful, but that taking it makes your use of the ideas more intense. Belief may be a tool, it may be expedient to take the step even if it is wrong.

the observer affects the outcome

The observer affects the outcome. Consider trust and faith as things that are affected by the truster as much as the trusted, jealousy can lead to unfaithfulness or at least constrain the actions of the trusted in negative ways.

belief as a tool rather than an end in itself

when you first come across chakras (see below for a description of chakras) often you are told to imagine them and subsequently after a period of time as you work with the imaginary structures you begin to feel them

Companies have a similar quality, a company is brought into being by imagining the structure and then manifesting it.

magick as heuristic

The line between magick and not magick is usually drawn by the observer

much that was magical is not anymore, modern science is science and not magic, chemistry is science and not alchemy

yoga is ordinary and is closer to aerobics in a lot of peoples minds than magic

occult as heuristic

occult as being constantly mined as a heuristic (and as a source of metaphors ..daemons etc)

Acupuncture and the whole concept of energy meridians have had no basis in modern science (research is just beginning to suggest otherwise). Western science has no model that supports these ideas. Yet western doctors have been recommending acupuncture and other 'unfounded' alternative therapies.

Mathematicians often arrive at something that is true without being able to describe the logical foundation or the whole chain of reasoning behind that answer, because they don't know it. Calculus is an example, calculus was used for a hundred years before the logical foundations began to be worked out. It was magic for a hundred years.

The alternative way to look at acupuncture, or calculus in its early stages, or any answer to a mathematical problem that you arrive at, are confident in, but have no clear incontrovertible basis for, is that your solution is heuristic. It as an answer that appears to work, that you find a basis for in parallel to using the answer while it still works.

Heuristics is a classic mathematical problem solving tool. Find the answer any way you can and then find a logical route to that answer. [see Pappus]

magick and the occult stripped of its conventional associations can be considered in heuristic terms

changing infrastructures

esoteric, occult, magick, ecstatic and hallucinogenic practices are often not ends in themselves but coded or explicit ways of altering what you are or might be.

gnosis

gnosis, that is various forms of trance, is central many of these changing infrastructures. Gnosis allows you to working on yourself at a low enough level

art objects

Art is a magickal technology. Both explicitly and implicitly.

art objects are magickal in the literal occult sense of being manifested expressions of will. Picasso produced highly charged objects with focused intent. Fetish objects.

Songs can be seen as sigils/mantras, pure cyclic statements of will and desire.

Art objects are also implicitly magickal in that they can create worlds with different rules and assumptions. Theatre employs elements of gnosis, by convention or realism causing suspension of disbelief, creating worlds with different rules and assumptions. Diggers, grifters, soldiers.

hypnosis

hypnosis is two things, a trance state and suggestion.

trance

trance states open you up, and make you susceptible to suggestion.

there are many ways of achieving a trance state, most connected with conventional hypnosis are based on the following pattern:

focusing attention, for example on some visible point.

deepening your breathing

shifting attention from external sensation to internal thoughts, spatial visualisation, memories or processes. e.g. focusing on your breath, visualising some real or imagined place, visualising chakras and energy flow.

Hypnotic trances ranges from light to deep somnambulistic states.

deepening the trance state often involves metaphors to do with progression and often descent. e.g counting up or down, descending stairs, visualising each of the chakras in turn, following a path leading somewhere tranquil.

hypnotists, often use challenges to establish a level of authority over their subjects. e.g. your eyelids are getting so heavy you cannot resist closing your eyes, your arms are so getting heavy

you cannot lift them (or so light that they rise up on there own)

in inducing a trance state the hypnotist is studying the subject and trying to appear authoritative and to reinforce (and therefore appear responsible for) what follows from a susceptible subjects increasingly altered state.

Milton Erickson described another method of establishing an initial trance. A subject would approach him and he would move as if to shake hands and as the subject reached out to him he would take the subjects outstretched right hand with his left and move it up. The split second of confusion that this caused erickson would use to establish the trance. Stage hypnotists use variations on this idea based on the confusion, disorientation and dislocation stemming from their subjects being in a stressful and potentially embarrassing situation. Shock, disorientate, suggest. Teachers and army officers use similar ideas.

suggestion and suggestibility

Hypnotists argue that it is extremely difficult to persuade a hypnotised subject to do something that clashes with the subjects core values, and consequently suggestion works by either constructing a real or imagined context in which the required suggestion makes sense to the subject.

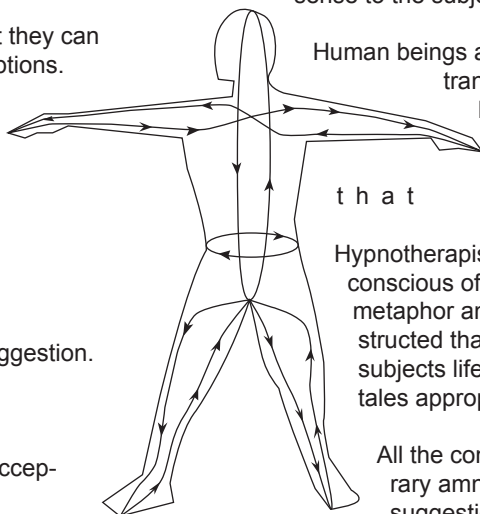

Human beings are just as open to suggestion whether in a trance state or not, but a trance state allows a hypnotist to work using the subjects internal constructs rather than having to construct real environments and social situations reinforce the suggestion.

t h a t

Hypnotherapists argue that entranced subjects are more conscious of the meaning of archetypes, symbolism and metaphor and that consequently stories can be constructed that relate to the resolution or exploration of a subjects life situation. Milton Erckson compiled books of tales appropriate to given situations and conditions.

All the conventional tricks of hypnotists, rigidity, temporary amnesia, triggering post-hypnotic actions rely on suggestion

“when i count to three you will..”

..ritual

ritual can be seen as a tool for creating states of mind and causing ‘appropriate’ behaviour and actions.

Psychedelic drug experiences can be heavily affected by ‘setting’ that is the circumstances in which the drugs are taken, this includes the physical environment (e.g. indoors or outdoors, natural or urban) and who you are with (e.g. close friends or hostile strangers). Aside from setting the other major influence is the ‘set’, the state of mind of the user. Set and setting often determine whether a trip goes well or badly, and more than that how fun, useful or therapeutic a trip turns out to be.

Almost any given socially constructed situation implies an appropriate behaviour or action.

Setting can provoke an intended state of mind and an intended behaviour or action.

Setting then can be seen as analogous to the hypnotists idea of suggestion

hypnotists maintain that people are susceptible to suggestion whether they are in a trance or not, and that suggestion can be encoded into a real or imaginary situation.

A trance allows the suggestion to be built out in the imagination of the subject rather than having to directly encode it into the environment.

Ritual as a tool is creating setting to induce set, direct a trip and manifest and reinforce a required reality

it can consequently be seen as a form of familiar form of spell casting.

Rituals can be built out of place and time, particular spatial organisations (architecture), clothing, forms of words, movement and behaviour,

a ritual can take the form of a trigger, causing the recall of an imprinted set

at a climbing gym before attempting a difficult route you might go through a ritual to get into a focused and positive frame of mind, the ritual may have practical value in that you calm your breath and stretch but going through the same pattern before each climb may also trigger a frame of mind linked to previous success.

constructing a ritual can create a framework for sanctioning a required state of mind and encode and provoke a required outcome.

[see 'future ritual' by phil farber]

divination

Methods of divination often involve the symbolic externalisation of forces active in the individual and in life.

Tarot cards combine archetypes with a chance element which is to some degree controlled by the reader. Which cards turn up and the arrangement of those cards give insight into the question which provoked the reading.

mesa (power objects laid out on the ground)

Every curandero has his 'mesa' [...] a collection of numerous power objects laid out on the ground in altar-like fashion for the curing sessions. The objects are of either positive or negative nature. The mesa symbolizes the duality of the world of man and nature and of the spiritual realm, as manifested in the struggle between good and evil. The opposites among the power objects are complementary rather than irreconcilable, rather like two sides of a coin.

To the curandero, the existence of opposite forces does not mean splitting the world in two (the 'sacred' and 'profane') or establishing a rigid dichotomy between 'this' world of matter and the 'other' world of the spirit. On the contrary, the curandero seeks to perceive unity in the dynamic interaction between the forces

of good and evil through the attainment of 'vision'. Such a view of the world is very flexible and adaptable; it leaves room for the acceptance of new symbols and ideas and allows competing elements to enter into one's structuring of reality and the behaviour determined by such structuring.

[...]

A witch or sorcerer would use this negative zone for sorcery or curing for lucrative gain; a benevolent curer like Galvaez needs it for consultation in cases of witchcraft, adverse love magic, or bad luck, since this is the realm responsible for such evils and consequently capable of revealing their sources

'Tobacco and Shamanic Ecstasy Among the Warao Indians of Venezuela' by Johannes Wilbert included in 'Flesh of the Gods, ed. Peter T. Furst Praeger Publishers 1972 and Drugs and Magic ed. George Andrews

Five classical magickal acts

Peter Carroll in Liber Kaos describes five classical magickal acts:

evocation [summoning entities for assistance] divination [e.g. tarot, i ching] enchantment [imposing your will on reality] invocation [taking the form of, or being possessed by, an archetypal form or spirit] illumination [changing yourself using magick]

Peter Carroll describes basic sorcery as the creation of "artifacts, tools and instruments which interact magically with the physical world and which can be used again in more subtle ways on other levels"

[really you want to be aware of it but skip past the whole siddhis thing and work on body focused energy work]

shamanism

A shaman is a medicine man, a healer, a creator and a fixer of worlds.

A shaman has highly developed esoteric energy intelligence

A shaman is a traveller, someone who exists in more worlds than others see.

A shaman uses gnosis (trance states and dreams) to effect change

the world we perceive is a subset of the worlds to be perceived, changing what or how we choose to perceive changes the world we live in. Huxley, Mckenna and Castenada all talk in terms that imply that the psychedelic experience is a removal of the brain valve or ego filter, a route to other forms of awareness. Castenada talks in terms of the assemblage point, the group of emanations that an individual chooses to see, an individuals reality. He talks in terms of developing new forms of attentiveness, increasing awareness, escaping socially conditioned perception and arbitrary 'ordinary' words. He emphasises stopping the world and learning how to see differently. If our awareness has no filter we become incapacitated and overwhelmed, so the subsequent emphasis is on learning how to scan and group emanations into useful worlds at any given moment. A shaman can move the assemblage points of others.

A shaman makes deals, for example with the plant allies that allow him to see or travel or heal.

curandero

What emerges from many hours of taped conversation with Galvaez and participation in his curing sessions is that the hallucinogenic San Pedro cactus is experienced as the catalyst that enables the curandero to transcend the limitations placed on ordinary mortals: to activate all the senses; project his spirit or soul; ascend and descend into the supernatural realms; identify and do battle with the sources of illness, witchcraft and misfortune; confront and vanquish ferocious animals and demons of disease and sorcerers who direct them 'jump over' barriers of time, space and matter; divine the past, present and future - in short to attain vision, 'to see'. And 'seeing', in the sense in which this word is used by the curandero, is very different from 'looking at'.

'Tobacco and Shamanic Ecstasy Among the Warao Indians of Venezuela' by Johannes Wilbert included in 'Flesh of the Gods, ed. Peter T. Furst Praeger Publishers 1972 and Drugs and Magic ed. George Andrews]

ways of thinking and learning

There are many layers to the way an individual relates to the world, many lenses (of differing strengths) that combine to make the composite lens through which the world is finally seen.

Emotional - how do you feel

Pattern finding ☺ what's the pattern

Associative ☺ what does this make you think of

Hormonal ☺ how the state of your body influences how you see things

Muscle memory ☺ how your training influences your reactions to things

Intellectual memory ☺ how does your training influence your reactions to things

Kinaesthetic ☺ how do I make my body do this

spatial - how far is it from here to there

Logical ☺ what just happened and what does that imply about what happens next

Abstract/mathematical ☺ is there an underlying predictable structure to what is happening

Visual ☺ what can I see

Verbal ☺ events as narrative

Social ☺ people

Lateral ☺ sideways approaches

Force lenses

- physical

- financial

- sex

- intellect

- charm

relationship lenses

- love

- friendship

- charity/concern

- position in a group [subordinate, leader, problem solver]

...guilt

Need lenses

- hunger

- greed

- love

- pain

- lust

- perceived necessity

perceived interest lenses

- right

- interest

- curiosity

chemical lenses

- medicinal

- spiritual

- recreational

a tribe called the mericans

'I hear there is a tribe called the mericans and they have visited the moon'

from the Songlines by Bruce Chatwin

evolution of magickal technology

Location aware devices will be the first generation of a new technological era, one in which a community will be able to collectively and dynamically impose invisible interpretations and community associations on any given place without physically altering it.

You can carry the externalised assumptions of your community with you instead of having to carve those assumptions into the physical environment.

Consequently magickal technology as it becomes progressively more advanced will give ever greater individual and community determined control over externally and internally perceived set and setting.

media evolution is linked to efforts to make the physical and community defined environment more plastic, to bring alternative (or dominant) models and assumptions into spaces that might encode different models and assumptions

printing presses, photography, cinema, music technology, radio, TV, computer games, web based content and communities, video projectors, cell phones...tagging, decoration, shelter building, festivals, signage, money

All these primitive early stage magickal technologies have in some way been harnessed by people grappling with the problem of making the built and community defined environment plastic and controllable.

occult and technological expansion of our ideas of what we are or might be

location aware devices are an occult project in the sense that they allow externalised portable support systems for whatever belief system you happen to be experimenting with at the time,

they will allow individuals and communities to secede from conventional ideas of what a space means or what we are or might be.

they represent the further evolution of external tools that acknowledge and support exploration and interaction with other realities.

create worlds of belief inside yourself and then externalise them.

magick vs cellphones

"when i was almost too small to remember I used to have this nurse in Haiti, a real magickal woman. This friend of hers used to sometimes go into town to the shops for her. If she'd forgotten to ask for something, she would walk into the garden and put her hand on this particular mango tree (with me in other arm) and she'd say '3 bags of sugar' or whatever it was she needed and always they'd return with what she'd asked for. Years later I went back and saw her. She had a cell phone. I asked her about the mango tree, and she told me it still worked but the cell phone magic was more reliable."

dreams

cooking

"we have all the ingredients but we still don't know what we're cooking" Douglas Adams

life flows into inanimate objects

"Life not content with it's own province, had flowed incontinently into the stones, river, stars and all the natural elements:

the external environment, because it was immediately part of man, remained capricious, mischievous, a reflection of his own disordered urges and fears." Lewis Mumford

gods for everything

In antiquity there were gods for everything, rivers, streams, trees, and animals.

This anthropomorphic view of the world made the external world an extension of man himself.

A whole new layer of information overlaying the world functions in the same way.

Precedents and models for a world like this stretch from science fiction and the occult to drug experiences and the myths and legends of ancient cultures.

every culture lives within its dream

"Every culture lives within its dream. It is reality while the sleep lasts, a culture lives within an objective world that goes on through its sleeping or waking, and sometimes breaks into the dream, like a noise, to modify it or to make further sleep impossible."

"The dream gives direction to human activity and both expresses the inner urge of the organism and conjures up appropriate goals."

Lewis Mumford

collective dreams as structuring agents

Culture is a dream, a set of arbitrary collectively agreed upon conventions. That dream is imposed upon reality. Everything in the built environment reflects upon how the collective sees itself. Visually appreciable characteristics and conventions vary between neighbourhoods, cities and states. Immigrant communities living together bring with them their own dream and overlay it on what they find (china towns, Latin quarters).

This externalised dream extends deep, if you have never stepped outside your culture, you may not notice how much of your world is mediated by an arbitrary dream.

collective dreams as structuring agents [science and politics are part of the dream]

Science, technology, art, literature, politics etc.

merging dream world and real world

We will be able to alter and experiment with the cultural interpretation and structuring of the physical world without physically altering it.

'He told me of how his real life and his dream life are becoming much the same.'

to make dreams truth and fables histories

"This was the sad ambience, the bitter, depleted world in which Lewis and Tolkien wrote. They had, however, a more positive response to these conditions and events than the postimperial stoicism, cultural despair, and resigned Christian pessimism that were the response of their British contemporaries. They were not prepared imaginatively and intellectually to withdraw and accept defeat. Out of the medieval Norse, Celtic, and Grail legends, they conjured fantasies of revenge and recovery, an ethos of return and triumph. As Chaucer said in Troilus and Criseyde, they aimed "to make dreams truth and fables histories" Inventing the Middle Ages, Norman F Cantor 1991

are there plants?

"We offer a simple test for otherworldly explorations: are there plants in the realm? And if there are, what is their status.

In natural, inhabitory societies everyone is a plant person. Sure, there are exceptions - the Eskimos lived entirely by eating other souls - but those are exceptions. To walk through the Amazonian forest with the Waorani or the Quichua speaking peoples is to be deluged with plant lore: with names, uses, and legends about plant after plant after tree passing by."

Pharmako/poeia - Plants, Posions and Herbcraft by Dale Pendell, mercury house san francisco 1995

does a firm persuasion of a thing make it so?

Then I asked: "does a firm perswasion that a thing is so, make it so ?" He replied: "All poets believe that it does, & in ages of imagination this firm perswasion removed mountains; but many are not capable of a perswasion of anything." William Blake

a new cathedral

We can experiment without needing to alter.

Think of this analogy in terms of real space. How much does it cost to build a new cathedral? Is the cost affordable for a small distributed community of relatively poor teenagers? How much to

alter and convert an existing building to some new purpose?

What if you could alter and convert real space and real spaces to serve your purpose without a legal change of ownership or real construction work.

'to make dreams truth..'

ideas trying to come into being

Soft augmentation is an idea that follows from current trends in technological advancement and investment.

information age daydream

merely trying to occur

"They are merely trying to occur, they are checking whether the ground of reality can carry them. And they quickly withdraw, fearing to lose their integrity in the frailty of realization. And if they break into their capital, lose a thing or two in these attempts at incarnation, then soon, jealously, they retrieve their possessions, call them in, reintegrate: as a result, white spots appear in our biography-scented stigmata, the faded silvery imprints of the bare feet of angels, scattered footmarks on our nights and days - while the fullness of life waxes, incessantly supplements itself, and towers over us in wonder and wonder..." Bruno Schulz - Cinnamon Streets

ideal engineers

"..peopled by unruly school groups being taught to idealise engineers" Umberto Eco

the planetary mind

"Computers - the gizmos themselves - have far less to do with techie enthusiasm than some half understood resonance to The Great Work; hardwiring conciousness, creating the Planetary Mind. Teilhard de Chardin wrote about this enterprise many years ago and would be appalled by the prosaic nature of the tools we will use to bring it about. But I think there is something sweetly ironic that the ladder to his Omega Point might be built by engineers and not mystics." John Perry Barlow

nodishness and spatialness

Augmenting human faculties, occult powers, changing the way we see the world and seeing deeper, hardwiring aspects of conciousness, merging dream and reality

mythology made alive

"Ritual is Mythology made alive." Joseph Campbell - The Masks of God

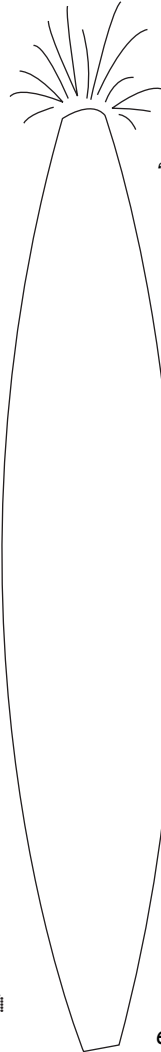

the erotic nature of automated universes

"But I also believe it was through her that he began to be aware of the erotic nature of automated universes" Foucault's Pendulum - Umberto Eco [page 223]

divides

Unaugmented people are going to live in a very different world, a divide as deep as rich and poor, educated and uneducated, race or political affiliation.

Framing and annotating nature

beauty is largely outside art galleries, and it should be unobtrusively sign posted

beauty outside

If art is about making us see what the artist wants us to see (Duchamp) then annotating nature could be art.

yugen

"To achieve the end of yugen, art had sometimes been stripped of its color and glitter lest these externals distract; a bowl of highly polished silver reflects more than it suggests, but one of oxidized silver has the mysterious beauty of stillness, as Seami realized when he used for stillness the simile of snow piling in a silver bowl. Or one may prize such a bowl for the tarnished quality itself, for its oldness, for its imperfection, and this is the point where we feel sabi. [...] The love for the fallen flower, for the moon obscured by the rain, for the withered bough, is part of sabi. Unlike yugen (to which, however, it is not opposed) sabi does not find in these things symbols of remoter eternities. They are themselves and capable in themselves of giving deep pleasure. Sabi also differs from the gentle melancholy of aware: here one does not lament for the fallen flower, one loves it." Tsunoda, et al, Sources of Japanese Tradition

making the stone stony

"And art exists that one may recover the sensation of life; it exists to make one feel things, to make the stone STONY. The purpose of art is to impart the sensation of things as they are perceived and not as they are known. The technique of art is to make objects "unfamiliar," to make forms difficult, to increase the difficulty and length of perception because the process of perception is an aesthetic end in itself and must be prolonged." Victor Shklovsky, Art As Technique

churinga (temporary and permanent)

The twofold nature of ownership characterizes all secret-sacred objects (churinga) and sites of mythological and ritual significance (Dreamings). For example among the Aranda each individual had a personal stone or wood churinga kept in a sacred 'storehouse' of the ritual group. The churinga is a lifeline to the spirit world and the dreaming - and people belong to it. The 'storehouse' may be a hole in the ground (where the churinga is buried), a hollow tree, a cleft in a rock or a shed of branches. In any case it is concealed from view and the whole area around it is forbidden to women, children and the uninitiated on pain of death. Thus while the concept of a sacred storehouse resembles that of other cultures, it is not expressed by building, and, rather than being stressed, is hidden.

A similar relationship exists between ritual groups and natural or artificially constructed Dreamings - standing stones, rock masses, waterholes, trees or stone arrangements. These are permanent and symbolic assurances of the presence of the Dreaming which are the very ground of being and keep the world going. The whole world is a single entity the main characteristic of which is reciprocity.

[...]

There is thus a clear distinction between sacred and profane, very much as Eliade suggests, even though there are no visible physical demarcations. For example when churingas were kept in caves, those entering to fetch them impressed palm prints near the entrance to establish rites of passage" indicating an awareness of a boundary between sacred and profane. In fact any place where churingas are kept becomes sacred, and the churinga is shown to initiate as a rite of passage giving rebirth into full membership of the clan. Similarly, ceremonial leaders frequently become such in special caves whereas other people who entered these caves could disappear forever. There are thus a number of rites of passage related to environmental features.

Some sacred places are specially related to the conception of children. When a woman conceives in a place where there are prominent features - rocks, boulders, ancient trees - one of the spirit children of the place enters her body and the totem of this place becomes the child's irrespective of the father's or mother's totem. This shows the importance of the place of conception and the individual retains a special relationship to the natural feature and would worry if the tree was to be cut down or the rock mined.

[...]

Many descriptions and illustrations exist of ceremonies all showing the great variety, richness and complexity of the temporary 'monuments' used - body decorations, shields, poles, crosses and the like. Various markers may be erected, rocks emphasized by having blood poured on them or special bough huts built in which men spend much time during ceremonies." During some ceremonials big fires are lit as "temporary monuments".

The various forms of body decorations are extremely complex involving painting, covering the body with down stuck with blood and so on as well as the use of extremely complex, elaborate and tall head gear. People so decorated could be seen as 'temporary monuments' claiming a place by making it sacred through linking it with myth.

[...]

While Western man relies on barriers to keep out nature, reduce differences between seasons and times and defines places by manipulating these barriers, aborigines define places by knowing them and their distinctions. This knowledge is perceptual and 'real' as well as associational, mythical and symbolic.

Amos Rapoport - AUSTRALIAN ABORIGINES AND THE DEFINITION OF PLACE found in Shelter Sign and Symbol ed. Paul Oliver - Barrie and Jenkins 1975

network conflict resolution

my god i dont want that

"Location aware device conversations often go like this: You explain the basic idea of location awareness: that is, that your cell phone will know where it is, and they go 'MY GOD, I DON'T WANT THAT.' And the conversation ends there. The reality is that the people who run the networks already know where your cell phone is to within a few hundred metres. The banks and shops already know from your credit card and store .loyalty. card transactions what you buy, and where you are when you buy it. Companies exist for the sole purpose of tracking your web habits, building files on you and selling that information to advertisers. A friend who used to work for one of the biggest of those companies (a computer science post-graduate specialising in privacy and encryption) just shakes his head and keeps saying .evil. whenever you ask him about his former employer (he left voluntarily). Your bank statements, your web profile, the cell phone towers you switch between, and your behavioural idiosyncrasies (and banalities), can all find there way into a file. They know where you are, where you were and have a reasonably good idea where you will be. They can know where everyone is except the people who tread carefully and the list of people who tread carefully is probably the worst one to be on. Oh, and as one Slashdot reader pointed out, it isn't good enough to turn your cell phone off you have to remove the battery, or better still tape the phone to the bottom of a greyhound bus headed in the other direction.

The location aware device stories that get into the mass media go: Strap bracelets to children and convicts; the more optimistic ones tell you how you can use this technology to get your BMW back. More recently they point out that in-car navigation systems can help you find the nearest McDonalds or 76.

The Teamsters union have clear policies on how and when location sensing can be used to track their members, and don't leave it up to the employer to decide. Organised, aware people help define this reality.

Until the internet arrived, broadcast media ruled, TV, newspapers, and publishers talked to us and we couldn't talk back on equal terms. The .one to many. function of the internet, and now all of a sudden cell phones, has changed that.

The one thing that hasn't happened is the localisation of these tools.

Location aware devices are a way to extend our capacity to talk to each other, and not just to some bunch of people spread all over the world but to the real next door people wherever you happen to be.

It's not that you have to meet them all. Non-contact communication is an important concept in this argument. Non-contact communication is stuff like war-chalking or hobo code. An example: homeless in the US in the 1920.s a guy finds a good place that.s safe to sleep, when he wakes up he leaves a chalk mark on the ground. Another homeless person comes along reads the hobo coded message and understands that this is a good place to sleep. Another example, a laptop user with 802.11 wireless LAN card walking down the street in San Francisco sees a chalk mark on the pavement, she sits down on the sidewalk next to the war chalk, flips open her laptop, and checks her email using the wireless connection the chalk told her was there.

These examples illustrate the way that location aware devices could be used to get people to communicate with each other on a local level to mutual advantage if they both do some chalking.

Location aware devices don.t use chalk. But you can leave messages about anything on the sidewalk, or anywhere else. If you want examples or you don.t know what location aware devices are you can find both on this site.

Your location is already being tracked. You could make good use of that information if you could get it and had a system for making use of it. Location services are a potential source of revenue for cash hungry mobile network providers so they are going to tell you where you are, and even if you ignore them they.ll still know; unless you throw away your much loved brand new super technical phone and stop using your credit cards.

The real issues are awareness and development, whether location information gets fed through an open source, peer to peer, encrypted system set up to help people help each other, or whether we just get to know where the nearest McDonalds is.

Asking people to think beyond 'MY GOD I DON'T WANT THAT' seems reasonable.

Anyway, us talking to each other is more scary than them knowing where we are, God knows what's going to happen."

social self organisation

When people consider the dangers of the chaos of a free intensely networked spatially augmented augmented world, they should also consider that like all technological advances it offers tools to both sides of any argument. 'ends appropriate means' may seem ominous but the ends can just as well be social advancement. Even in a critical situation, disaster response and recovery in a world of spontaneous peer to peer mesh networks, running evolved social software, seems like a sane option for coordination of local efforts to recover and help from outside. The homeland security initiative raised the point that a citizen owned spatially aware communications network could be invaluable in a crisis.

People self organise for all kinds of reasons and geomesh networks offer any number of socially and personally advantageous opportunities.

Catching people who want to hurt other people could be made a lot easier with local communities watching out for themselves according to local and personal value systems instead of or supplementing often alienating top down invasive tactical operations.

location based services for homeland security

[...] Second, experience shows that redundant communications are extremely important in crisis situations. Multi-modal communications are crucial to crisis operations. Terrestrial networks may fail during a catastrophic event. Wireless networks provide additional choices, including cellular packet, radio packet, and satellite networks.

Add to this the emerging Wi-Fi network (based upon IEEE 802.11b), with nodes that are rapidly popping up across the U.S., and we will have an affordable broadband connection with the field. (Visit Wi-Fi grassroots movement if you are interested in step-by-step instructions on how to build your own inexpensive Linux 802.11b node.)

Location-Based Services for Homeland Security By Harry Niedzwiedek

balance between the liberating and controlling aspects of technology

technology is not inherently liberating.

If location aware devices reach the mass market in a form that does not cryptographically protect the user, governments and corporations are soon going to know exactly where everyone is in real time.

local law

"According to Lawrence Lessig, a Stanford law professor, the notion that governments can't regulate [the internet] hangs upon a particular architecture of the Net. As the Internet's architecture changes and becomes more complex, with the addition of services like filtering and geolocation, the idea that the Internet is beyond the reach of local laws and government regulation looks less and less tenable."

The Economist, Aug 9th 2001, Geography and the net - Putting it in its place

states and companies with computers vs individuals with computers

"Telecommunications equipment and computers have tended to centralize the power held by the top officials in both government and private industry. Computer experts often reject this complaint. They contend that the rapid growth in the use of personal computers by millions of American citizens will cancel out the increases in power flowing to the large organisations. This defence has surface plausibility, but when the vast capital, expertise and manpower available to the large government and business organisations are compared to the capital, expertise and available working time of even the most favoured individual, the personal computer does not appear to be a great equaliser.

Furthermore, who controls what information is stored in the great data bases of the united states and who serves as the gatekeeper to most of the giant communications networks."

[...]

"Is it reasonable to believe that a dedicated band of environmentalists, sending electronic smoke signals to each other via their home terminals, really will be able to effectively match the concentrated power of a giant oil company or committed government agency."

David Burnham - The Rise of the Computer State

"I'm only the prime-minister"

"these vehicle checkpoints or VCP's, were part of the first, trial phase of the operation vengeful computer system" [1974] DC

The king has note of all that they intend,

By interception which they dream not of.

[WS Henry V, II 2. via 'The Puzzle Palace']

"According to fashionable new police jargon, espoused by both police and their radical critics, policing is 'merely a subsystem of the total system of social control'. That description of 'the job' was given in 1985 by Metropolitan Police Commissioner Sir Kenneth Newman, as the police and home office jointly promoted new multiple agency ideas about crime control. Comprising the 'total system of social control' are central government departments, including the DHSS; employment, education and environment ministries; and local government agencies, including housing, education, planning and social services. Commissioner Newman's systems theory was a fair summary of the police approach to the search for a new role in the community during the 1980's"

[1986 On the Record: Surveillance, Computers and Privacy, DC and SC]

"imagine if the Watergate mob had control over the national data banks" [1974]

"'You know,' he once told me, 'It's hard to believe it really happened. But it can happen again in America. Americans like to make rules, and that scares me. If you have too many rules you get locked in a system. It's the system that says this one dies and that one doesn't, not the people. That's why I don't hate the German people. Individuals yes. Rules, yes. But not all Germans.' he shrugged. 'They just obeyed the rules. But that's why we need more Commodores. We need more mavericks, just so the rules don't take over.'" [founder of Commodore, an Auschwitz survivor]

"Orwell's telescreen is now technically feasible."

"Employers fear change in their workers, governments fear change in their citizens, churches fear change in their parishioners" Pharmako/poeia - Plants, Posions and Herbcraft by Dale Pendell, mercury house san francisco 1995

[marines get more info from public networks]

"Robert Steele is a US intelligence officer with eighteen years experience, including tours with the CIA as a clandestine field officer. Four years ago, he was in charge of setting up a new US \$20 million computerized intelligence centre for the Marines.

It was to be linked to the CIA's central database of classified information. When the connection was made, Steele eagerly began sending queries from the Marine network to the CIA, requesting the kind of data Marines want to know, such as "What was the turning radius for ships in Brazilian ports? How much weight could the bridges of Jordan withstand?" To Steele's utter shock, the CIA database proved useless. No one had warned him that the classified information he and thousands of other CIA operatives had been generating for years was, in the main, worthless.

From that moment, Steele's epiphany has led to a personal crusade to eradicate the secrecy that plagues the intelligence apparatus. Steele discovered he could have found immediate and correct answers to his queries on the 'open' market of information - commercial databases, academic sources, and public computer networks. "Secrecy," Steele says, "corrupts truth." The 50,000 bureaucrats in the intelligence community believe, he adds, "that if it is not a secret, it's not worth knowing." Yet Steele quotes internal studies that show up to 75 percent of classified information is available from open sources at an incredibly cheaper cost."

[concludes with a conference announcement: "The keynote speaker will be Alvin Toffler. Also four former KGB officers will explain how they used open sources in the US to learn almost everything they needed."]

Kevin Kelly - WiReD

men are better than gates

"but men are better than gates and no gate will endure against our enemy if men desert it."

community as exoskeleton

men are better than gates

society as shelter

social organisation as shelter

dragging networked communities into the real world

elements of a religious cult

incense

music

dance

sex

charismatic leader

submit personal possessions

dogma

ritual

home

land

work

subversiveness networks

Not only civil society but also "uncivil society" is benefiting from the rise of network forms of organization. Some uncivil actors, such as terrorists and criminals, are having little difficulty forming highly networked, nonhierarchical organizations.

"I bomb, therefore I am."

Terrorism enables a perpetrator to publicize his identity, project it explosively, and touch the nerves of powerful distant leaders. This kind of attraction to violence transcends its instrumental utility. Mainstream revolutionary writings may view violence as a means of struggle, but terrorists often regard violence as an end in itself that generates identity or damages the enemy's identity.

Netwar figures increasingly at the societal end of the spectrum, where the language has normally been about low-intensity conflict (LIC), operations other than war (OOTW), and nonmilitary modes of conflict and crime.

Hierarchies have a difficult time fighting networks. There are examples across the conflict spectrum. Some of the best are found in the failings of governments to defeat transnational criminal cartels engaged in drug smuggling, as in Colombia.



Most adversaries that the United States and its allies face in the realms of low-intensity conflict-international terrorists, guerrilla insurgents, drug smuggling cartels, ethnic factions, as well as racial and tribal gangs-are all organized like networks (although their leadership may be quite hierarchical). Perhaps a reason that military (and police) institutions keep having difficulty engaging in low-intensity conflicts is because they are not meant to be fought by institutions.

Cyberwar may imply a new view not only of what constitutes "attack" but also of "defeat."

from John Arquilla, David Ronfeldt, and Michele Zanini - see note for full text source

non state actors

Conventional wisdom in international relations maintains that the nation states exist in anarchy, that is above states there is nothing.

feudal lords [warlords]

pirates [private armies]

joint stock companies

free cities [principalities]

monasteries

[...]

Terrorists

global companies and corporations

NGO's

Churches

independent fortunes

Media moguls

financiers

Organised crime

[...]

temporary real communities [Festivals, conferences, raves etc]

networked concentrations of interest [slashdot, hyperreal etc]

intentional communities [auroville, arcossanti, harbin]

non-state trading hubs [ebay like]

non-state interest groups [anti-WTO]

[...]

nomads

hackers

crackers

spin doctors

fighting technology

military monastics

The military constantly redefine organisational structure, space, movement, control, and conflict, in terms of technology

[helicopters, supersonic planes, computers, automatic weapons, satellite communications and imagery, night vision, atom bombs, laser guided munitions, aircraft carriers, submarines, tanks, missiles, GPS]

electronic battle weapon

[early adoption, spatial weirdness, application, development e.g. GPS as military tech]

let slip the toys of war

"cry havoc and let slip the toys of war."

men are better than gates

"but men are better than gates and no gate will endure against our enemy if men desert it."

the c(Four)ISR architecture

Activities with the C4ISR architecture are being prioritized and held under the auspices centrally within the Department of Defense.

The C4IsR architecture being developed and which is necessary for implementation of JV 2010, has the following components:

- o A robust, multi-sensor network, for achieving Dominant Battlespace Awareness (DBA) - information superiority.

- o A common communications system with sufficient ability, inclusive speed and ECM jamming, as support for operations.

- o An advanced "command and control" function that enables rapid deployment and logistics support to troops (faster than an opponent's).

- o A "sensor-to-shooter" system that integrates air defence, precision weapons and enables more effective battle damage assessment.

- o A global information defence system for active protection of own sensors positioned globally and communication networks from enemy interference or exploitation.

- o The capability for information operations which enable us to either penetrate or mislead an opponent's corresponding systems, thus preventing information superiority with an opponent.

from a talk by Jan Foghelin

cu chulainn

fidchell

At that Cu Chulainn's riastarthaе overcame him

so that the air was full of their blood

[...]

The man has long, braided beautiful hair; his face is half red and half white and bright and glistening all over. His cloak is dark blue and crimson.

"Not to avoid danger have we come," said Cu Chulainn

[...]

Then his riastarthaе came upon him. You would have thought that every hair was being driven into his head. You would have thought that a spark of fire was on every hair. He closed one eye until it was no wider than the eye of a needle; he opened the other until it was as big as a wooden bowl. He bared his teeth from jaw to ear, and he opened his mouth until his gullet was visible. The warrior's moon rose from his head.

[...]

Cu Chulaind cast his spear at Foill and broke his back and took his head and his weapons.

Cu Chulaind cast his spear at Tuachell, and the latters limbs collapsed; he went and struck Tuachell's head off and gave the head and spoils to Ibor.

[...]

then his riastartha came over him: a drop of blood appeared at the tip of each hair, and he drew his hair into his head, so that, from above, his jet-black locks appeared to have been cropped with scissors; he turned like a mill wheel, and he stretched himself out until a warrior's foot could fit between each pair of ribs.

"Not difficult, that" she answered

He cast it at the boy through the water, and the boy's innards fell at his feet.

from Early Irish Myths and Sagas - penguin

indistinguishable

"simulation on computer mediated weapons systems can be made almost indistinguishable from real engagement. Constant simulated warfare can be supplemented with occasional live feeds."

who says the streets are reality?

"who says the streets are reality? We call a fresh bunch of crackheads an episode"

never at the hot gates

"I was never at the hot gates

Nor fought in the warm rain

Nor knee deep in the salt marsh, heaving a cutlass,

Bitten by flies, fought"

T.S. Elliot

sixteen thousand tons of pure symbolism

"Today the USAF, despite being the richest organisation of its kind anywhere, can scarcely afford to buy more than 100 fighters annually. At up to \$500 million apiece - the price of a single 'stealth' bomber - so rare are modern weapons systems that, like some fake antiques, they have to be virtually hand crafted. Since new major systems seldom reach operational status at planned cost, there is always a tendency to pare numbers and stretch programs, causing per-unit price to escalate. Once the weapons exist they are too expensive to be tested or trained with, so that

simulators have to be used. Finally, when low-intensity conflict does break out and the opportunity to use the hardware presents itself, it seems wasteful to employ such expensive systems against persons who are often an illiterate rabble, and who are not even regular soldiers. As a result, in Lebanon for example, the US Navy's first air-strike (leading to the loss of two aircraft, total value perhaps \$60 million) was also the last. Summa summarum, already today only one country can afford to own more than a handful of these systems; nor does even the US intend to replace those lost in the Gulf."

"16,000 tons of pure symbolism "

martin van creveld - on future war

military monastics (armies as communities)

"As a group we have sought a life not only of proud service to country, of challenge, and of adventure, but also one that is a microcosm of tradition, order, hierarchical structure, predictability, and unequivocal response to clear demands. There is an element of the cloister in this, our life of dedication and sacrifice, full of the satisfactions of early rising and hard work - our carefully structured life, routinized, homogenous, full of universally understood symbols."

General John R. Galvin - Uncomfortable Wars -towards a new paradigm of low-intensity conflict [1991]

(seekers)(Keeny meeny)(warrior pilgrims)

we are pilgrims master;

we shall go always a little further;

it maybe beyond that last blue mountain bar'd with snow,

across that angry or that glimmering sea

from Fletchers - The Golden Journey to Samarkand

i looked for death

"I looked for death in battle but I have not died"

"My nostrils are filled with the smell of blood. My eyes are glugged with the sight of bleeding bodies and shattered limbs, my heart wrung with the agony of wounded and dying men"

Bickersteth Diaries

Future war

"one important way in which human societies of any kind develop their internal structure has been through fighting other societies."

"In another sense, the question as to what future societies war for is almost irrelevant. It is simply not true that war is solely a means to an end, nor do people necessarily fight in order to attain

this objective or that. In fact, the opposite is true: people very often take up one objective or another precisely in order that they may fight. While the usefulness of war as a means of gaining practical ends may well be questioned, its ability to entertain, to inspire, and to fascinate has never been in doubt. War is life written large. Among the things that move between the two poles, war alone both permits and demands the commitment of all man's faculties, the highest as well as the lowest. The brutality and the ruthlessness, the courage and the determination, the sheer power that strategy considers necessary for the conduct of armed conflict are at the same time its causes. Literature, art, games, and history all bear eloquent testimony to the same elemental fact. One very important way in which men can attain joy, freedom, happiness, even delirium and ecstasy, is not by staying at home with wife and family, even to the point where, often enough, they are only too happy to give up their nearest and dearest in favour of war."

Van Creveld - Future War

business metaphors

"the metaphor for business is no longer war, now its a cocktail party"

[more vicious than ever]

halo

"Other specialist methods of parachuting have been developed. HALO has spawned HAHO (High Altitude High Opening). This allows the parachutist to be under the canopy shortly after leaving the aircraft. Its advantage over HALO is that the parachutist can take advantage of the forward drive of the canopy to travel many miles over the ground. This allows for the aircraft to drop the troops without having to overfly the target, whereas for HALO this is not the case."

no profit

"no profit without power and no security without war"

endless

"endless sheets of butcher paper"

at least half of them secondary school and college graduates

"Britain hadn't recovered psychologically before the sixties, possibly the eighties, perhaps never, from those miserable photos of February 1942, showing slim, diminished, embarrassed British officers in their little khaki shorts surrendering Singapore to exultant, masterful Japanese generals, or those heart-stopping photos of smiling young British bomber crews about to leave for their near suicidal night missions over Germany in 1943 and 1944 and the loss of 59,000 air crews, the cream of a generation, at least half of them secondary school and college graduates..."

Inventing the Middle Ages - Norman F Cantor 1991

antidiplomacy

"Diplomacy is the art of saying 'nice doggie' until you can find a rock." Will Rogers"

James Der Derian - Antidiplomacy

war universe

"this is a war universe, war all the time" William Burroughs

deep black

"the large black security blanket" Deep Black - William Burrows

superfortress

"it's what we call a hemisphere defence weapon" The B-29 Superfortress

into battle with standard office equipment

"according to my sources the modern army is planning to go into battle [...] with standard office equipment."

Brock Meeks

under the carpet

"So expensive, fast, indiscriminate, big, unmanoeuvrable, and powerful have modern weapons become that they are steadily pushing contemporary war under the carpet, as it were; that is, into environments where those weapons do not work, and where men can therefore fight to their hearts content." [third world, terrorism, crime, SO/LIC etc]

martin van creveld - on future war [or James Der Derian - Antidiplomacy]

watch for gaps and slack

"Hide your form, be orderly within, and watch for gaps and slack." Sun Tzu

the fall of empires is always dangerous

"The fall of empires is always dangerous and seldom leads to the tranquil prosperity that their enemies anticipate. It is most unlikely that the dissolution of the greatest of all 20th century empires will be accomplished peacefully." Patrick Brogan, 'World conflicts.' Bloomsbury, 1989

the lowest quality image, the highest representation of reality

"a powerful combination of the latest technology, the lowest quality image, the highest representation of reality."

"Two simple statements by two disparate 'mud soldiers' frame the architecture of cyberwar. The construction and destruction of the enemy would be: - measured in time not territory. - prosecuted in the field of perception not politics. - authenticated by technical reproduction not material referents. - played out in the method and metaphor of gaming, not the history and horror of warring."

"The wizards in desert khaki came out from behind the curtain only long enough to prove their claims on TV screens, to have us follow their fingers and the arcs of the bombs to the truth. At some moments - the most powerful moments - the link between sign and signifier went into Mobius-strip contortion, as when we saw what the nosecone of a smart bomb saw as it rode a laser beam to its target, making its fundamental truth claim not in the flash of illumination but in the emptiness of a dark screen." James Der Derian - Antidiplomacy

smart bombs

"the written word lost out to the video of a video of a bomb that did not need books to be smart."

conflicting values

your word

He sat down and his father heard him out and when he was done he nodded.

All my life, he said, I been witness to people showin up where they was supposed to be at various times after they'd said they'd be there. I never heard one yet that didn't have a reason for it.

Yessir.

But there ain't but one reason.

Yessir.

You know what that is?

No sir.

It's that their word's no good. That's the only reason there ever was or ever will be.

Cormac McCarthy

grifter

*"no sense being a grifter if its the same as being a citizen"
Gondorf [Paul Newman] in The Sting*

working

"Nietzsche says somewhere that the free spirit will not agitate for the rules to be dropped or even reformed, since it is only by breaking the rules that he realizes his will to power. One must prove (to oneself if no one else) an ability to overcome the rules of the herd, to make one's own law & yet not fall prey to the rancor & resentment of inferior souls which define law & custom in ANY society. One needs, in effect, an individual equivalent of war in order to achieve the becoming of the free spirit_one needs an inert stupidity against which to measure one's own movement & intelligence."

"don't get caught in the crossfire, keep your back covered but take the risk, dance before you calcify."

Hakim Bey

belief

"the belief that values could be dispensed with constituted the new system of values"

builders

seek influence not office

support the prophets against the kings

be the same in and out of office.

build amidst the confusion of others

fear

It is the beginning of a journey.

I am filled with fear.

AL Rowse

stowaway

"A man (they swore they had known him) had planned to stow away on a boat bound for Chile. It was laden with manufactured goods packed in big wooden crates, and with the help of a docker the stowaway had managed to hide himself in one of these. But the docker had made a mistake about the order in which the crates were to be loaded. The crane gripped the stowaway, swung him aloft, and deposited him - at the very bottom of the hold, beneath hundreds of crates. No one discovered what had happened until the end of the voyage, when they found the stowaway rotting, dead of suffocation."

George Orwell - Down and Out in London and Paris

history

"there was a close and continuing dialectic between the voyages and the extension of knowledge."

counter culture research and development

counter culture research and development

The spatial and social weirdness that location aware devices are going to make possible is prefigured by the spatial and social experimentation of the counter-culture.

Since the 1960's the counter-culture has functioned as a much-needed r&d department for western societies.

The counter-culture explored alternatives to dominant forms of social and spatial organisation ..emphasising: temporary, spontaneous, mobile, communal, free, sharing, heterarchical, networked, autonomous.

It consciously explored the plasticity of the built environment, social structures and technology; it's explorations were spatial, imaginative, communal and constructive.

It set an agenda, which is far from complete, and only just becoming technically feasible.

The counter-culture has been (and still is) experimenting with new technology and new ways of using space and organising community, and this despite the extent and violence of opposition it has faced.

From Haight Ashbury to Burning Man, only the US military can claim to have been as curious, radical or as irresponsible in exploring the social and spatial possibilities offered by new technology.

Despite being troublesome and deniable at the time, the most disruptive counter-culture ideas usually find themselves assimilated into mainstream thought.

experimentation

The counter-culture has been experimenting with social organisation, it has explored, invented and colonised new and old spaces.

continuity

a continuous line can be drawn from the 60's to the present day

trace root

"The dominant narrative of failure of the sixties counterculture is frequently repeated in books about it. Dates in titles of books signal this: Elizabeth Nelson's *The British Counter-Culture*, 1966-73, Nigel Fountain's *Underground: The London Alternative Press 1966-74*, Alan Beam's *Rehearsal For The Year 2000 . . . 1966-1976*. The cut-off dates alter, but there's a general reluctance to pursue the alternative project via any actions of the next generation. These books display a shortening gap between the bemoaned 'end' of the counterculture and the straggly dyed green shoots of the next youth antagonism, punk rock. Fountain and Nelson are particularly guilty here: the focus of both their texts is

*the underground press, yet neither even mentions the explosion of fanzine culture which accompanied and contributed to the energy of the punk scene, clearly a prime example of an underground press. Not all hippy activists or writers about the scene are so myopic. In 1972, the underground publication *Frendz* optimistically proclaimed 'if flower-power has gone to seed then germination must soon begin. And what King Weeds they'll be'."*

"[the] utopian project of the sixties is still with us - in fact it never really went away."

George Mckay

exploration

the counterculture has experimented with using the space differently since the 60's

haight

In the late 1960's Haight Ashbury, a cross-street in san francisco, became the consensus epicentre of a new counter-culture.

Media coverage resulted in a massive migration which the original community was unable to absorb.

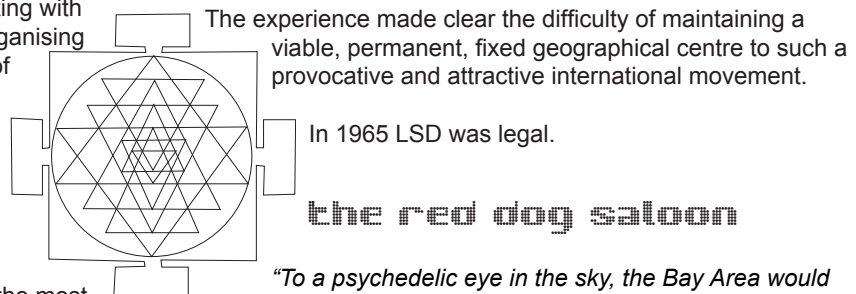

the red dog saloon

"To a psychedelic eye in the sky, the Bay Area would have looked like a maze of tiny puddles of acidheads, each ignorant of the others. The Red Dog Saloon was one place where people could get an inkling - from out in Nevada - of how big it was becoming. [1965]

[...]

The Be-In was a great long stare in the mirror for the psychedelic community [jan 14th 1967]"

Charles Perry, *Rolling Stone*, 1976

seekers

"But then the seekers came en masse, enticed by the media." Don Mcneill, Village Voice, Nov 30 1967

william burroughs

"The sensational press formula as laid down by the late William R. Hearst is to play up sex, drugs and violence with one hand while denouncing them with the other. Sex drugs and violence are copy." William S. Burroughs writing in IT

playpower

"The bright elusive butterfly has landed on the shoulders of the fifteen-year-olds." Richard Neville, *Playpower*

the superficial aspects

"They came to the Haight," a handbill relates, "with a great need and a great hunger for a loving community. Many, wanting to belong, identified with the superficial aspects of what 'hippie' was. They didn't drop out but rather changed roles.

"As a result the tone of Haight-Asbury changed. With many people coming in expecting to be fed and housed, the older community tried to fulfill their needs. Rather than asking them to do their thing, the community tried to give them what they came for. The community tried to be something it wasn't.

"The early members tried to save the community and as a result it began to die. It began to die because in the effort to save it the individuals lost themselves. Without individual selves the community started to become a shell with little within; to maintain the community feeling, meetings replaced relationships and organization replaced community.

"By the end of the summer we were forming organizations to save something that no longer existed. Community is a creative thing and saving is only a holding action. By desperate clinging, we lost."

from Don McNeill, *Village Voice*, Nov 30 1967

Keep moving

"I lived a block above Haight street for two years, but by the end of '66 the whole neighborhood had become a cop-magnet and a bad sideshow. Between the narks and the psychedelic hustlers, there was not much room to live."

"one good scene after another had been first settled, then publicized, then busted. The pattern had almost become a ritual." Hunter S. Thompson - *The Proud Highway* 1968-1976

temporary doctrine

This pattern became part of counter culture methodology, temporary has become a doctrine and a virtue.

temporary, like concerts, and not enduring like the pyramids

"I imagine a future architecture in which you turn on a building the way we now turn on the lights. These buildings will be temporary, like concerts, and not enduring like the pyramids; and so when the use of the building is finished, the people can move on. The culture will be similar to the nomadic way of life of the old Paleolithic hunters and gatherers; the people will carry their culture in their souls, and so familiar will they be with earth, wind, and stars that civilization will be unnecessary." William Irwin Thompson, *Darkness and Scattered Light*

diggers (Free cities)

Theater is territory. A space for existing outside padded walls. Setting down a stage declares a universal pardon for imagination. But what happens next must mean more than sanctuary or preserve. How would real wardens react to life-actors on liberated ground? How can the intrinsic freedom of theater illuminate walls and show the weak-spots where a breakout could occur?

Guerrilla theater intends to bring audiences to liberated territory to create life-actors. It remains light and exploitative of forms for the same reasons that it intends to remain free. It seeks audiences that are created by issues. It creates a cast of freed beings. It will become an issue itself.

This is theater of an underground that wants out. Its aim is to liberate ground held by consumer wardens and establish territory without walls. Its plays are glass cutters for empire windows.

Free store/property of the possessed

The Diggers are hip to property. Everything is free, do your own thing. Human beings are the means of exchange. Food, machines, clothing, materials, shelter and props are simply there. Stuff. A perfect dispenser would be an open Automat on the street. Locks are time-consuming. Combinations are clocks. [Check this: "locks" in the 10/66 edition?]

So a store of goods or clinic or restaurant that is free becomes a social art form. Ticketless theater. Out of money and control.

"First you gotta pin down what's wrong with the West. Distrust of human nature, which means distrust of Nature. Distrust of wildness in oneself literally means distrust of Wilderness." --Gary Snyder

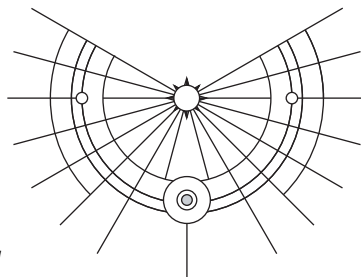

Diggers assume free stores to liberate human nature. First free the space, goods and services. Let theories of economics follow social facts. Once a free store is assumed, human wanting and giving, needing and taking, become wide open to improvisation.

A sign: If Someone Asks to See the Manager Tell Him He's the Manager.

Someone asked how much a book cost. How much did he think it was worth? 75 cents. The money was taken and held out for anyone. "Who wants 75 cents?" A girl who had just walked in came over and took it.

A basket labeled Free Money.

No owner, no Manager, no employees and no cash-register. A salesman in a free store is a life-actor. Anyone who will assume an answer to a question or accept a problem as a turn-on.

Question (whispered): "Who pays the rent?"

Answer (loudly): "May I help you?"

Who's ready for the implications of a free store? Welfare mothers pile bags full of clothes for a few days and come back to hang up dresses. Kids case the joint wondering how to boost.

Fire helmets, riding pants, shower curtains, surgical gowns and World War I Army boots are parts for costumes. Nightsticks, sample cases, water pipes, toy guns and weather balloons are taken for props. When materials are free, imagination becomes currency for spirit.

Where does the stuff come from? People, persons, beings. Isn't it obvious that objects are only transitory subjects of human value? An object released from one person's value may be destroyed, abandoned or made available to other people. The choice is anyone's.

The question of a free store is simply: What would you have?

Street event -- birth of haight/funeral for \$ now

Pop Art mirrored the social skin. Happenings X-rayed the bones. Street events are social acid heightening consciousness of what is real on the street. To expand eyeball implications until facts are established through action.

[...]

The Post-Competitive, Comparative Game of a Free City

free families in free cities.

We must pool our resources and interact our energies to provide the freedom for our individual activities.

In each city of the world there is a loose competitive underground composed of groups whose aims overlap, conflict, and generally enervate the desired goal of autonomy.

Free City:

Free City Switchboard/Information Center

Free Food Storage and Distribution Center

Free City Garage and Mechanics

Free City Bank and Treasury

Free City Legal Assistance

Free City Housing and Work Space

Free City Stores and Workshops

Free Medical Thing

Free City Hospital

Free City Environmental and Design Gang

Free City Schools

Free City News and Communication Company

Free City Events . . . Festival Planning Committees

Cooperative Farms and Campsites

Scavenger Corps and Transport Gang

Free City Tinkers and Gunsmiths, Etc.

Free City Radio, TV and Computer Stations

[extracts from digger publications; see www.digger.org]

turnips

"the Diggers [operating in Haight Ashbury] miraculously provide thousands of servings of stew a day, operate free stores, and offer community services. Disdainful of ideology, theirs is the dialectic of action. Diggers do, they say, and in spite of their predilection for burning money, they manage to substantiate the economics of free." Notes from the underground, ed. Jesse Kornbluth

"everyone tries to find out who sponsors the digger FREE FOOD. the CP thinks it's in the SP, the SP thinks it's the CP, SDS thinks it's PLP . . . they all know it's a conspiracy. well the diggers despise conspiracy ...the old left... ...the new left... they're indifferent to their tactics and don't even bother talking to them... (SDS NATIONAL COMMITTEE invited D I G G E R S to their national conference: "no thank you, but thanks just the same. you see. it's getting late. and well. the turnips. for chrissake the turnips!"

Diggers Do, Inner Space 3, June, 1967

the underground press

Underground presses, and advances in printing technology played a major role in organising communities and spaces, and expressing alternatives.

By the end of the 1960's radical underground presses were supporting, informing and holding together a rapidly expanding alternative community. Music, free festivals, political radicalism and the back to the land movement all relied for an uncensored voice on the ability to self-publish.

The FBI went to considerable lengths to undermine and destabilise the more radically inclined presses, coordinating damaging raids with pressure on advertisers in order to force them out of business.

Through underground presses, individuals and groups could bypass mainstream media and publish, uncensored, what would otherwise have spread only by word of mouth, functioning as precursors to the free for all of the uncensored internet and the formalised word of mouth of the Lonely Planet's.

[Avatar, IT, Oz, the Whole Earth Catalog, Rolling Stone, Inner Space, Shelter.][[Marshal McLuhan]

underground media

The post 1960's counter-culture has expressed itself through a succession of new technologies, photocopied zines, desktop publishing, the internet.

The internet has made possible organised archives of alternative information [vaults of erowid etc]

Lonely Planet is online

There are syndicated alternative/protest media to rival mainstream

news networks [indymedia]

Mailing lists and websites support marginal interests of every conceivable character.

Cheap access to tools for making music, film and printed matter mean that the range of media, and the number of people with access, have massively increased.

Counter-culture's experimentation with alternative media didn't die in the early 1970's..

What maybe died was the idea that consistently alternative and contrary might be everybody's religion. The counter-culture is an imaginative, creative, international tribe, with an influence disproportionate to it's size. It is just the r&d department, but what comes out of the r&d department affects how things get done in the future.

The next generation will have location aware devices that will allow direct invisible collective marking, demarcating and annotating of space.

From communes to open source

In the 1970's there was a 'back to the land' movement, hippies moved out of urban environments into the 'countryside'. This was in part an expression of a more general interest in communal living and self-sufficiency.

The communal experimentation of the late 60's and early seventies resulted in some of the most constructive and thoughtful contributions to come out of the counter-culture during the period.

These efforts served to substantiate the hippies claim to be looking for a genuine alternative infrastructure.

The Whole Earth Catalog, set up by Stewart Brand, a biologist who found himself in Tom Wolfe's Electric Kool-Aid Acid Test as the hippie who noticed that despite the ongoing space program there were no pictures of the earth from space. The pictures that later emerged have been credited with catalysing the environmental movement, creating an awareness of how fragile the earth's ecosystem might be and challenging the myth of inexhaustible natural resources.

The Whole Earth Catalog's articulated a political agenda that rejected the ideas of the new left and conventional revolutionary politics in favour of a grass roots revolution based on constructive alternative ideas. The catalogs supplied ideas, tools and resources that supported the back to the land movement. They focused on the fledgling interest in ecology and whole systems, the creative exploration of new (and old) technology from house building, to computing to renewable energy, new (old) ideas about internal energy (alternative medicine, yoga, meditation, tai chi, acupressure, acupuncture and massage).

Shelter, another great publication from the period, focused on architecture without architects, documenting small scale self-building techniques, ranging from historical, international and hippie

house building experimentation.

"Nobody heckles a hippy when he's high on work"

The Whole Earth 'Lectronic Link (the WELL), spun off from the Whole Earth Catalog and was an early (1980's) and influential California based bulletin board that soon got itself hooked up to the internet. Stewart Brand founded the Hackers conference which brought (and still brings) together a diverse range of computer geeks. A former Whole Earth editor Kevin Kelly was the first editor of Wired magazine.

Linux and the open source (free) software movement parallel the ideas that Shelter and Whole Earth exemplify, in that they fundamentally challenge conventional preconceptions about how things could or should be done.

Linux and free software are infrastructure. Linux and the open source (free) software movement, have, by just building, imposed, de facto, new forms of community, value and exchange. It is hard to marginalise a counter-culture that can offer alternatives that rival the most successful orthodox institutions.

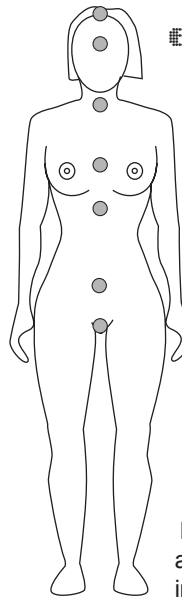

etymologically perhaps

"A psychedelic community? Chemically, no. We consider drugs unnecessary. But etymologically, perhaps. We are alive."

Drop City: A Total Living environment, Albin Wagner, Avatar, august 4, 1967

rethinking land

When people from urban environments move into the country they can find themselves feeling out of place.

When the hippies headed back to the land they brought a belief system with them that was often at odds with that of the communities they moved into. Locals often largely perceived agricultural land in the context of work, and maximised production. The hippies brought in new ideas about how they would live, what the land meant to them and how it should be worked. This inevitably led to a harsh dialogue, if not a direct conflict. Organic farming is one result of this argument.

The hippies who went back to the land in the seventies were often highly intelligent and hard working, land was relatively cheap so that now many of the communes that survived are land owning and relatively financially secure. Many hippy intentional communities failed but some like Harbin in northern California and Findhorn in Scotland have survived. The evolving survivors often function on different levels, on the one hand as collective communes for long term residents, more or less true to the original founding ideas, and on the other as commercial retreat centres catering to increasingly mainstream interest in yoga, meditation and alternative therapies.

One weirdness is that since the 1980's the original hippy lifestyle has been increasingly commercialised and commodified, what were once cheap alternatives are now sold at a premium. 'Organic' brown rice is now a luxury item. Whole Foods, a hippy health food supermarket in San Francisco, is probably the single

most expensive place to buy groceries in the whole city.

Many of the original hippy's are wealthy and influential and many of the original hippy motifs have been co-opted as symbols of wealth and power. Whether this is success or failure depends on where you stand.

heuristics

Acupuncture and the whole concept of energy meridians have no basis in modern science [new research is in fact beginning to suggest otherwise]. Yet western doctors prescribe and recommend acupuncture and other 'alternative' therapies. Western science has no model that supports these ideas.

Mathematicians often arrive at something that is true without being able to describe the logical foundation or the whole chain of reasoning behind that answer, because they don't know it. Calculus is an example, calculus was used for a hundred years before the logical foundations began to be worked out. It was magic for a hundred years.

The alternative way to look at acupuncture, or calculus in its early stages, or any answer to a mathematical problem that you arrive at, are confident in, but have no clear incontrovertible basis for, is that your solution is heuristic. It as an answer that appears to work, you find a basis for it in parallel to using it.

Heuristics is a classic mathematical problem solving tool. Find the answer any way you can and then find a logical route to that answer. [see Pappus]

acupuncture

massage and acupressure

yoga

tai chi

meditation

vegetarians

vegans

organic farming

self-built homes [shelter]

whole earth catalog

energy efficient housing and solar power

Linux

[The UN recently began sending yoga and tai chi teachers into former war zones]

intentional communities

'intentional community' is a formal way of saying commune.

Intentional communities are interesting as a physical manifestation of community derived from common interest.

Deciding to be together in real life ..after deciding that the idea of being together was worth dragging into reality.

Intentional communities usually get formed by people who have in common, religious, political, artistic, sexual or other fairly utopian ideas.

For many intentional communities, now is a good time, the internet making it easier for seekers to find them.

a).external communes beyond [or before the closure of] the map: virginia [dee, raleigh, prospero, caliban] pirate networks

b). internal communes within [or after the closure of] the map: paris commune, whole earth, harbin]

auroville ø india

paolo soleri - arcossanti [arcology]

shelter - lloyd khan

whole earth magazine [+ catalog]

osmotic cohousing (rentals.com etc)

harbin

burning man

pick one...

<http://www.ic.org/iclist.html>

<http://www.ic.org>

build utopia[s]?

the hippy trail

hippies were hip because they knew.

They new because they had travelled. From the east to the west coast, from india to south east asia, from morroco and constantinople to europe

dialectic

"there was a close and continuing dialectic between the voyages and the extension of knowledge."

the road to Kathmandu

This hirsute new breed of travellers packs a socially disruptive valence way beyond the significance of its numbers.

the Road to Katmandu

A spectre is haunting the world: the spectre of long hair. [...] In May 1967, in a joint statement, the Greek Minister of the Interior and the Minister of Public Order proclaimed: 'Entry is prohibited of any foreigner who is unclean and not dressed properly.' [...] The Consulate-General in Istanbul added helpfully: 'It is not only young

men. Young women are also involved.' He went on to explain that the consulate had to deal with '1000 problem youngsters a year'. [...] By December 1967, the virus had struck central Asia. In London, The Times revealed that "flower people" arriving in Nepal will now receive visas valid for only one week and not renewable.' A hippie camp near Katmandu was disbanded and the leader deported. [...] May 1968, a group of twenty-two travelers (the first 'batch') were expelled by the Laos authorities [...] Before these luckless deportees were admitted to next-door Thailand, they were made to shave their beards and cut their hair. [...] In July 1968, Yugoslavia officially 'declared war on hippies' and the Belgrade newspaper Politika Ekspres reported that groups of boys armed with scissors had been forcibly carrying out haircuts on long-haired visitors. [...] In Mexico border guards began turning longhairs back with the words: 'No hippies, no Jews; on Presidential orders.' [...] By April 1968, Argentinian police had arrested 133 'hippies' and sheared their hair to crew-cut length. In September, the Turks officially banned 'louseniks' from the country [...] In October 1968, the Times of India reported that: 'Some New Delhi magistrates are wondering whether there is a sinister pattern behind the hippie invasion of the capital.' [...] In Marrakesh, the bizarrely beautiful, velvet and satined Western girls tell stories of angry, veiled Arab ladies rushing up, shaking them and asking, 'Who are you? Who are you?' [...] In Bangkok, Western travellers are cleared from cafes by nervous Thais with sub-machine guns [...] 'Who is in charge of you? What are your plans? Where are your headquarters?' asked the Greeks when they gaoled Neal Phillips, an American traveller for hash offences [...] Nowhere is inaccessible. They tramp through Africa and South America. In Bangkok I met a couple who had hitch-hiked through China. [...] I met young Americans who had thumbed through South Vietnam, only to be attacked - not by Vietcong - but by 'Vietnik'-hating, uniformed fellow countrymen [...] It has been estimated that over two thousand British 'hippies' passed through Kabul Afghanistan, in 1967

from Playpower by Richard Neville 1971

out

the hippies were out of place

lonley planet

Lonely Planet books grew out of a hippy culture that saw people drop out and travel

The third world has been opened up, by written down word of mouth, to unbelievably large numbers of young westerners without much money.

The lonely planet now represents a corridor that now runs throughout the third world, You can stay anywhere along that corridor, meet people like yourself, eat western food, sit in restaurants watching the latest movies on pirated DVD [while the pigs nuzzle around under the whole in the floor that is the toilet], send your email, buy deoderant, condoms, antibiotics and sunblock, and eventually fly home with a backpack full of fake stussy clothing, tag hauer watches, cracked software, pirated CD's, difficult to obtain prescription drugs, a hammock and a new sarong.

third world networks

Cyber cafes have sprung up all over the third world not just to service travellers, but also to supply the local business community and a local middle class hungry for access to computers and email.

Local trade both internal and across international borders benefits from cheap reliable communications.

The general case can be made specific.

Networks are impacting more than just the relatively wealthy westerners in the third world, at the interface between the travellers and the local population, the local community can leverage the new infrastructure for there own ends.

Small scale manufacturers who used to have trouble keeping in contact with the travellers who came through and ordered stuff to ship back to them in the west can now take reorders by email and bypass the difficulties of time difference, the costs of conventional long distance phone calls and government postal systems. Using the web they can also reach deeper into those markets once they know they exist.

Facilities of every kind (guest houses, diving shops, climbing shops, trekking shops), have websites, often built for them by travellers to make costs cheaper; the sites bring in new business, email keeps them in touch with travllers who have returned home and may come back or tell there friends.

using networked computing in the third world

Once you get past high cost of hardware the software's free, and its the latest stuff, same software the rest of the world is using, with all the productivity advances that software brings.

You can homebrew anything the west has with a computer. In Kathmandu the stores don't have tills, they have old computers running till software written in india.

The internet phone revolution has made calling internationally affordable.

Cell phone infrastructure often causes conventional land line systems to be bypassed, leading to isolated areas being able to go from nothing to 21st century infrastructure over night.

alt.cereal

barefeet

exoself

astrolabe

alt.pictures.binaries.children.starving

Satellite tv is free if you crack the encryption and wire everybody to the same feed

Pirated cd's and MP3 compilations from russia give low cost access to music and something to sell to travellers

Copyright violations constitute incalculable aid to the third world

Future orientation

mobile phones, wireless networks and location aware devices

Drifters used to leave chalk marks which indicated stuff like the suitability of a particular spot for sleeping

The old lonely planets were a slow paper age equivalent

When cell phones know where they are and function as networked computers, nomads are going to see marks left by their community in a much more dynamic way.

your location in space, your geographical coordinates can define your home

no longer geographically dislocated in your networked existence

your position is your home

[...]

meditation centres, vegan restaurants, bookstores, and friends living locally are all marked on her display

It can make her aware of spontaneously occurring events as they happen

It can generate spontaneous directed disorder

She sees invisible marks left for her by others as she walks

The walls of the labyrinth that she was stuck behind and constrained by are made transparent, and further, her view of the space is centred on her interests and her community.

[imagine a device which registered state next to the names in a list of your friends e.g. Tim (bored) Anna (busy) Sally (in transit)]

[you have handwritten directions to somewhere and you're lost and you think to yourself if I had the right device I could solve this problem really easily [check the address, find directions, get a map]

your whole physical environment can become part of the interface

three days

"Only 150 years ago, the Great Plains were a vast, waving sea of grass stretching from the Chihuahuan Desert of Mexico to the boreal forest of Canada, from the oak-hickory forests of the Ozarks to the Rocky Mountains.

Bison blanketed the plains-it has been estimated that 60 million of the huge, shaggy beasts moved across the grassy ocean in seasonal migrations. Throngs of Pronghorn and Elk also filled this Pleistocene landscape. Packs of Gray Wolves and numerous Grizzly Bears followed the tremendous herds.

In 1830, John James Audubon sat on the banks of the Ohio River for three days as a single flock of Passenger Pigeons darkened the sky from horizon to horizon. He estimated that there were several billion birds in that flock. It has been said that a squirrel could travel from the Atlantic seaboard to the Mississippi River without touching the ground so dense was the deciduous forest of

the East.

At the time of the Lewis and Clark Expedition, an estimated 100,000 Grizzlies roamed the western half of what is now the United States. The howl of the wolf was ubiquitous. The California Condor sailed the sky from the Pacific Coast to the Great Plains. Salmon and sturgeon populated the rivers. Ocelots, Jaguars, and Jaguarundis prowled the Texas brush and Southwestern mountains and mesas. Bighorn Sheep ranged the mountains of the Rockies, the Great Basin, the Southwest, and the Pacific Coast. Ivory-billed Woodpeckers and Carolina Parakeets filled the steamy forests of the Deep South. The land was alive.

East of the Mississippi, giant Tulip Poplars, American Chestnuts, oaks, hickories, and other trees formed the most diverse temperate deciduous forest in the world. In New England, White Pines grew to heights rivaling the Brobdingnagian conifers of the far West. On the Pacific Coast, redwood, hemlock, Douglas-fir, spruce, cedar, fir, and pine formed the grandest forest on Earth.

In the space of a few generations we have laid waste to paradise. The Tallgrass Prairie has been transformed into a corn factory where wildlife means the exotic pheasant. The Shortgrass Prairie is a grid of carefully fenced cow pastures and wheat fields. The Passenger Pigeon is no more; the last one died in the Cincinnati Zoo in 1914. The endless forests of the East are tame woodlots. With few exceptions, the only virgin deciduous forest there is in tiny museum pieces of hundreds of acres. Fewer than one thousand Grizzlies remain."

Dave Foreman

[the railroads, the steel plough, the six shooter, steel windmills and barbed wire]

[...]

"Even wild animals resisted the destruction of their homelands under the hooves of invading livestock. Many of the so-called 'renegade' Gray Wolves, who undertook seemingly wanton attacks on cattle and sheep, were the last surviving members of their packs and had seen their fellow pack members trapped and killed. Arizona's 'Aguila Wolf' ('aguila' is Spanish for eagle) killed up to 65 sheep in one night. Near Meeker, Colorado, 'Rags the Digger' would ruin trap lines by digging up traps without tripping them. Many of these avenging wolves were trap victims themselves, bearing names like 'Crip', 'Two Toes', 'Three Toes', 'Peg Leg', and 'Old Lefty.'

Whole communities would marshal their resources to kill the last of the wolves. 'Three Toes of Harding County' eluded over 150 men in 13 years of attacking livestock in South Dakota. As recently as 1920, a trapper worked for eight months to kill the famous 'Custer Wolf.' East of Trinidad, Colorado, ran a renegade wolf called 'Old Three Toes', the last of 32 wolves killed in Butler Pasture. This lonely wolf befriended a rancher's collie, who was penned into a chicken run to keep him away from the wolf. One night they found freedom together by digging from opposite sides of the fence. The collie never returned home, and was killed weeks later by a poison bait. Old Three Toes and her litter of Gray Wolf-collie whelps were discovered shortly thereafter and all were killed."

T. O. Hellenbach

quotes from ecodefense - A field guide to Monkeywrenching, edited by Dave Foreman and Bill Haywood (foreword by Edward

Abbey)

temporary autonomous zones

temporary autonomous zones

The counter-culture has specialised in using technology to create temporary autonomous zones: spontaneous and temporary communities, in part a response to the failure of geographically fixed centres of exploration and resistance.

From free festivals, protests, direct actions and be-ins to their modern incarnations; modern mutations have included raves and burning man. Burning man is an entire temporary city existing only for a week that conjures up an airport, radio stations and satellite uplinks, all of which get dismantled at the end leaving nothing but the flattest stretch of desert in the USA. Burning man continues the tradition of questioning ideas of value and exchange, nothing is for sale, there is no advertising and you are invited to participate not spectate.

The long tradition of environmental protest and direct action since the 1960's has resulted in all kinds of temporary communities. Greenpeace ships, British all-women CND camps outside the Greenham Common USAF cruise missile base, anti-road protesters living in trees, the spontaneous concentrations of dissent surrounding the WTO and G8 summits.

[adapt]

The Haight Ashbury scene was effectively buried under the weight of a spontaneous semi-permanent migration provoked by mainstream media attention.

Clubs like UFO in London [set up in part to fund the underground press] live short intense lives defining a moment and a scene before dying under the weight of all the media attention they generate.

The counter-culture's focus on temporary autonomous zones is in part a collective realisation that concentrations of original, good or useful energy can be made more resilient by keeping them mobile, spontaneous and temporary.

secular religion (plus electronica)

entheogens, communion, dancing and beats, linked to ritualised contexts and times

secular religion

[bhuddist shrine and incense in eklektic]

electronica

music generates and defines spaces

"I knew the psychological power of music and noise, the way they produced saturday night fevers in discos. The German woman's eyes were wide, and every movement of her hysterical limbs begged for oblivion. The other daughters of the saint went into

ecstasy, flung there heads back, wriggled fluidly navigating a sea of forgetfulness." Foucault's Pendulum - Umberto Eco

a culture bent on inducing ecstatic trance states and body highs

the way electronic music has evolved has lead to a mainstream international culture of beats, violent repetitive movement and [optional] chemical intoxication

body awareness

dancing to fast beats is not difficult and dancing rather than not dancing is now normal - however bad you are you can find some simple pattern and repeat it endlessly

moving to beats opens you up

engages your body without taxing your brain too heavily

and [assuming your not in a french night club choking to death from the smoke - or anywhere doing way too many drugs] you should be no worse off for going out

energy weirdness

esoteric body weirdness fuses with popular culture

music provides context and changes the shape of working, driving and dancing

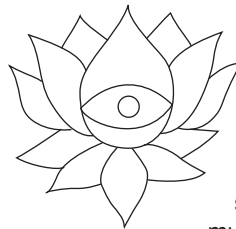

music and technology have generated new kinds of temporary spaces

electronic music has inspired and mediated new forms of temporary social organisation

spontaneous and temporary communities created by music and technology

new music, new drugs, new technologies ..access to cars, cell phones, pagers, pirate radio stations and new music, desk top publishing and digital printing

..spontaneous organisation of positive disorder

technology facilitating temporary spaces

[coming together at a point in space and time and then splitting apart]

a rave scene merged with what remained of the alternative and festival scenes

neutral undefined spaces act as hosts [deserts, fields, empty warehouses]

communications mediated by the new internet technologies

elists and the web hold together international communities and enable the easy distribution of software for creating and distributing new music [trackers like buzz, mp3s etc]

access to once underground or unavailable resources relating to drugs [vaults of Erowid] and event listings [with sites like www.hyperreal.com holding disparate resources together]

[live]

two 14 year old british kids holding together a trance party in Goa with a pair of portable DAT machines and a mixer playing tracks they just made that afternoon

lines of uninvited drummers

fusing human voices, traditional instruments, real time filtering and sound generators, presets, vinyl

the people moving around you are real

entheogens

a secular religion

electronica and the culture surrounding it has grown out of a basically secular society

it is ritual, aspirational, and contains elements of early religious practice [analogous to ecstatic aspects of the shamanic, pagan and voodoo traditions]

getting lost in deep house music is bliss, you can get there [and arguably higher] without taking anything, but the subtext of house is a sequence of build ups, crescendos and plateaus which overwhelm and bliss people on ecstasy.

unfamiliar location

many people

darkness and disorientating pulses of light

fast loud bass heavy beats

violent repetitive body movement

[secular religious activity]

entheogen is a replacement for the word psychedelic with additional implied meaning

see the council on spiritual practices section on religion and psychoactive sacraments

'an entheogen chrestomathy'

<http://www.csp.org/chresomathy/>

[for more on the future of entheogens read 'Holy Fire' by Bruce Sterling]

Fela Kuti

Paroah Sanders

Tito Puente

Sun Ra

spatial nature of music explored through dance

when you dance your arms and hands find ways through the temporary spaces of the crowd

your torso flexes and twists, and movement flows rhythmically

through your whole body.

music filled with spatial cues and slow lucid large gestures and measured breathing.

feeling hollow and sinewy and alive reaching into the light for clarity.

A room full of those temporary spaces.

fluidly navigating the sea of forgetfulness

[no tape]

music can function as an interface to the space

with a location aware device you could associate music to a bounded geographical space, if spaces with sounds attached to them intersect you could get harmonies ..blind people could use sound based interfaces to spaces.

insurrection has festive aspects

'Participants in insurrection invariably note its festive aspects, even in the midst of armed struggle, danger, and risk.'

Meanwhile, however, we turn to the history of classical anarchism in the light of the TAZ [Temporary Autonomous Zone] concept.

Before the "closure of the map," a good deal of anti-authoritarian energy went into "escapist" communes such as Modern Times, the various Phalansteries, and so on. Interestingly, some of them were not intended to last "forever," but only as long as the project proved fulfilling. By Socialist/Utopian standards these experiments were "failures," and therefore we know little about them.

When escape beyond the frontier proved impossible, the era of revolutionary urban Communes began in Europe. The Communes of Paris, Lyons and Marseilles did not survive long enough to take on any characteristics of permanence, and one wonders if they were meant to. From our point of view the chief matter of fascination is the spirit of the Communes. During and after these years anarchists took up the practice of revolutionary nomadism, drifting from uprising to uprising, looking to keep alive in themselves the intensity of spirit they experienced in the moment of insurrection.

Sort of a spiritual hedonism, an actual Path of Pleasure, vision of a good life which is both noble and possible, rooted in a sense of the magnificent over-abundance of reality." Hakim Bey

"from among the experiments of the inter-War period I'll concentrate instead on the madcap Republic of Fiume, which is much less well known, and was not meant to endure.

Gabriele D'Annunzio, Decadent poet, artist, musician, aesthete, womanizer, pioneer daredevil aeronautist, black magician, genius and cad, emerged from World War I as a hero with a small army at his beck and command: the "Arditi."

At a loss for adventure, he decided to capture the city of Fiume from Yugoslavia and give it to Italy. After a necromantic ceremony with his mistress in a cemetery in Venice he set out to conquer Fiume, and succeeded without any trouble to speak of.

*But Italy turned down his generous offer; the Prime Minister called him a fool. In a huff, D'Annunzio decided to declare independence and see how long he could get away with it. He and one of his anarchist friends wrote the Constitution, which declared music to be the central principle of the State. The Navy (made up of deserters and Milanese anarchist maritime unionists) named themselves the *Uscocchi*, after the long-vanished ones who once lived on local offshore islands and preyed on Venetian and Ottoman shipping.*

*The modern *Uscocchi* succeeded in some wild coups: several rich Italian merchant vessels suddenly gave the Republic a future: money in the coffers!*

Artists, bohemians, adventurers, anarchists (D'Annunzio corresponded with Malatesta), fugitives and Stateless refugees, homosexuals, military dandies (the uniform was black with pirate skull-&-crossbones later stolen by the SS), and crank reformers of every stripe (including Buddhists, Theosophists and Vedantists) began to show up at Fiume in droves.

The party never stopped.

Every morning D'Annunzio read poetry and manifestos from his balcony; every evening a concert, then fireworks. This made up the entire activity of the government.

Eighteen months later, when the wine and money had run out and the Italian fleet finally showed up and lobbed a few shells at the Municipal Palace, no one had the energy to resist."

Hakim Bey

Festivities often border on insurrection

[degenerates can get you in and degenerates can get you out]

Burning Man is a huge, week long, annual, temporary autonomous zone. 30,000 people turn up in the middle of the Nevada desert and build a city from scratch. The city has an airport [built that week], more radio stations than London, is focused on, and full of, temporary art objects (full-size submarines surfacing out of the desert, vast disfunctional satellite dishes and ramps for launching corpses into orbit). The whole thing is clothing optional, and fuelled on good energy, every conceivable kind of dance music, yoga and some drugs.

Nothing gets sold at burning man. You can actually buy carrot juice but you have to barter for everything else. There are no adverts, no sponsorship and no logos.

It always looks like it won't happen again but it keeps happening.

In 1999 someone did a perfect swan dive off a 100 ft tower into the desert floor.

Met a bunch of internet billionaires at burning man. One fellow I spoke to had just floated on NASDAQ and had his share in his company valued at \$100 million. He was dispensing free entheogens.

The rules break down at burning man, the energy is positive and the people are good. It's self governing and has its own police

force [black rock rangers] who keep people from jumping into fires and tell you where you can park.

People ride around the desert on motorised sofas and make smudged art with their genitals

the Free Festivals

The free festival at the farm in 1978 happened when a convoy had left Stonehenge after the solstice to go to another free festival we were planning. It was the early days of making the vision of festivals being a summer-long nomadic culture real. We'd identified a field at Cinnamon Lane in Glastonbury as the site - there had been a small alternative culture settlement there for a number of years, caravans and a tipi. I'd lived there myself. But when we turned up the farmers and police knew about it and had blocked off the access. The police radio'd around and eventually came up with the venue of Worthy Farm, so we all headed there under police direction. I remember seeing Andrew Kerr there, and him saying 'This is better than '71'. I think it was this free festival that rekindled Michael's interest in holding another festival, the '79 Year of the Child one. Actually it was Rebecca, Michael's daughter, and Andrew Kerr - it was their interest that was rekindled.

[...]

Yet in the earlier days of Stonehenge relations with the authorities could be less confrontational. Police used their car headlights to illuminate the stage when the power failed one year, while during the long hot summer of 1976 the fire brigade sprayed water for the hippies to dance and play in around the stones

George Mckay

convergence

Glastonbury happens in the summer in the middle of Wiltshire in England. It's more music orientated than Burning man and it rains more often. The principal is the same, normal rules are suspended for the week with the mass of people turning up for the weekend.

Glastonbury attracts all kinds of people, hippies, ravers, travellers, anarchists, miscellaneous alternative types and people who just sneak off from jobs and from school.

People dance all night, some get naked, some take drugs, much temporary art and social interaction, everyone lives in temporary camps although with not so much radical emphasis on their construction as the theme camps at burning man.

Hackers at the end of the Universe and DefCon, Dutch and American (respectively) hacking, cracking and law enforcement conferences.

During the course of both conferences rules get suspended and stuff happens. The law enforcement and Cracking communities interact in an atmosphere that hints at a temporary cessation of hostilities.

People hack and crack and tell others how to do the same. They give lectures on how to pick locks and steal time from phone companies.

Sometimes (like just now) people get arrested

Survival Research Laboratories [SRL]

Under the freeway in San Francisco, SRL build huge robots..

..they weld chain saws, flame throwers and other dangerous junk to them. They wait til it gets dark, get thousands of people to sign waivers saying that if they die its their own fault and then have a party while the robots fight each other

Random events are not always so easy to find, they are not always marked on calendars.

www.burningman.com

hackers at the end of the universe/Defcon

glastonbury

SRL

tribal gatherings and raves

[temporary autonomous zones]

the point at which you hit the highway on the way out.

'At Glastonbury one year, after a week inside, I remember hiking out early to the perimeter through all the madness and reaching the outside. I remember being shocked by the clean, sterile tarmac after all the mud. There were police there and blue lights silently flashing, and police radios. The officers looked clean cut and stern and slightly concerned in an outside sort of way. Like border guards or worried fathers. It was like leaving a country, stepping out into something less.

Leaving Burning Man one year I remember when we finally got clear of the dust thrown up by the desert and onto a proper road. I was OK until we stopped at a roadside restaurant and I walked in barefoot wearing a sarong. Realised I was on the outside and felt very sad.

Driving back from burning man to san francisco a girl hunched low on a very fast, dusty, and too big for her motorbike shot past at incredible high speed. The hair on the back of my neck stood up. I realised the burning man population was abruptly splitting up, dispersed in all directions. Temporary convergence over with. People charged with new energy, moving outwards.

Positive subversive spirit intact and spreading.

You come out different.'

some existentialists are not plant people.

I am afraid of cities. But you mustn't leave them. If you go too far you come up against the vegetation belt. vegetation has crawled for miles towards the cities. It is waiting. Once the city is dead, the vegetation will cover it, will climb over the stones, grip them, search them, make them burst with its long black pincers; it will

blind the holes and let its green paws hang over everything.

Jean-Paul Sartre, Nausea [via Pharmako/poeia - Plants, Posions and Herbcraft by Dale Pendell, mercury house san francisco 1995]

a typical nomadic band consists of

"the typical hunter/gatherer nomadic or semi-nomadic band consists of about 50 people. Within larger tribal societies the band-structure is fulfilled by clans within the tribe,"

Hakim Bey

yesterday and tomorrow

"yesterdays ideological labels, like communism and capitalism, have little to do with the problems of tomorrow"

protest

[zapatistas, WTO/G8, IMC]

wto

International protest focused on the physical, symbolic and electronic manifestations of WTO and G8 summits can be traced back to the zapatista observation that the globalisation of corporate capitalism needed to be matched by a globalisation of resistance. This would involve a broad based coalition targeting the manifestations of this globalisation.

WTO protestors from Seattle to Genoa, exhibit a high level of decentralised and despatialised organisation. But the results of this organisation are a highly focused convergence by protestors (from all over the world and from a whole range of different interest groups) on the physical and temporal locations of WTO related meetings wherever in the world they are held.

how was the w.t.o. protest in seattle organised?

The internet, toilet walls, flyers, Word Of Mouth - communication channels existed which were discrete, cheap and fast enough to facilitate and motivate massive spontaneous disorganised cooperation between disparate groups with common interest.

Since Seattle an international decentralised networked communications infrastructure (mostly internet based) has been set up to bypass the traditional media and report events from the protestors point of view.

Indymedia, a fully fledged syndicated news network, takes camcorder footage, first hand accounts and interviews and distributes them through a network of international websites.

Often this news channel is the common thread the holds the coalition together and despite not being a faction themselves they are often described as such by the traditional media; by the act of reporting they (de facto) direct the protests. The Italian police at the Genoa protests broke in, smashed computers, stole tapes and discs, then lined people in a building across the road up against a wall and beat them unconscious.

A key problem with the evolving hydra-headed protest movement is differentiating peaceful from violent protest, agent provocateurs from genuine protestors, and violence directed towards symbolic targets from general looting. This was less problematic when the movement was starting out, but it has grown and attracted increasingly opportunistic and unsympathetic elements and its tactics and strategy have been scrutinised.

..It would be interesting if different groups of protestors (within the larger coalition) were better able to identify and demarcate themselves spatially at demonstrations.

..so that some differentiation in the style of protest among a wide range of participating groups was visible to outside observers who usually come away with only the images of the most violent and aggressive demonstrators in their heads ..and the implied inference that these images are representative of all the demonstrators.

The media (even the independent media) has insufficient tools for effectively representing or mapping the experience of the different parts of the whole rather than the most visually or viscerally arresting.

If a section of the demonstrators normally associated with peaceful protest are demarcated and still become engaged in clashes with riot police, and come away covered in blood the message is a different one to 'protestors clash with riot police'

Peaceful demonstrators are often there, and in the majority, and are not heard or represented properly. Police brutality, unsympathetic violent elements and agent provocateurs are a documented reality and it may take some technological skill to differentiate the voices of non-violent protestors and convey their experiences. Violent protest directed at property may have its place but when it repeatedly fails to clearly hit its target and drowns out significant attempts at non-violent protest, the media (traditional and non-traditional) and the protestors should be working to find ways of differentiating the two voices.



zapatistas

AN INSURGENCY BECOMES A NETWAR

On New Year's Day 1994, some two to four thousand insurgents of the Zapatista National Liberation Army (EZLN) occupied six towns in Chiapas, declared war on the Mexican government, proclaimed radical demands, and mounted a global media campaign for support and sympathy. Through its star-quality spokesman "Subcomandante Marcos," the EZLN broadcast its declarations...

[...]

The Mexican government's initial reaction was quite traditional. It ordered army and police forces to suppress the insurrection, and downplayed its size, scope, and sources, in keeping with official denials in 1993 that guerrillas existed in Chiapas.

[...]

...it [EZLN] called a press conference and issued communiqués to disavow Marxist or other standard ideological leanings. It denied

all ties to Central American revolutionaries. It clarified that its roots were indigenous to Mexico, and its demands were national as well as local in scope. It appealed for nation-wide support for its agenda - which included respect for indigenous peoples; a true political democracy, to be achieved through the resignation of President Carlos Salinas de Gortari, the installation of a multi-party transition government, and legitimate and fair elections; and the enactment of social and economic reforms, including repeal of revisions in 1992 to Article 27 of the Constitution governing land tenure, and, by implication, the reversal of NAFTA. In addition, the EZLN called on civil society to engage in a nationwide struggle for social, economic, and political reforms, but not necessarily by taking up arms. The insurgents denied that they had a utopian blueprint, or had figured out exactly how to resolve Mexico's problems. They also soon denied that the EZLN itself aimed to seize power. Finally, they called on international organizations (notably, the Red Cross) and civil-society actors (notably, human-rights groups) from around the world to come to Chiapas to monitor the conflict..

[...]

This active response by a multitude of NGOs to a distant upheaval - the first major case anywhere - was no anomaly. It built on decades of organizational and technological groundwork, and shows how the global information revolution is affecting the nature of social conflict. The NGOs formed into vast, highly networked, transnational coalitions to wage an information-age netwar to constrain the Mexican government and support the EZLN's cause. The Zapatistas are insurgents. But the widespread argument that they are the world's first post-Communist, postmodern insurgents makes a point that misses a point: Their insurgency is novel; but the dynamics that make it novel - notably, the links to transnational and local NGOs that claim to represent civil society - move the topic out of a classic "insurgency" framework and into an information-age "netwar" framework. Without the influx of NGO activists, starting hours after the insurrection began, the dynamics in Chiapas would probably have deteriorated into a conventional insurgency and counterinsurgency - and the small, poorly equipped EZLN might not have done well. Transnational NGO activism attuned to the information age, not the EZLN insurgency per se, is what changed the framework - but it took Marcos' sense of strategy to make the change work.

Dealing with civil-society NGOs - whether as allies, as in humanitarian and disaster relief operations, or as antagonists, as in some cases of pro-democracy, human-rights, and environmental movements - is a new frontier for government officials around the world.

IMPLICATIONS BEYOND MEXICO

This case indicates that social netwar can be waged effectively where a society is open, or slowly beginning to open up; where divisive social issues are on people's minds; and where outside activist NGOs and their networks have local counterparts with which to link. Such a society should be in a region where the activists have a well-developed communications infrastructure at their disposal for purposes of rapid consultation and mobilization. Because of such conditions, Mexico provides a much more susceptible environment for social netwar than do more closed societies (e.g., Burma, Cuba, and Iran) that are not yet fully connected to the Internet.

"designing strategies to open up closed societies"

'A Comment on the Zapatista "Netwar"' - David Ronfeldt and Armando Martínez

netwar and zapatista note

Netwar and zapatista fragments and quotes are from the work of John Arquilla, David Ronfeldt, and Michele Zanini. The full texts, from which this material is drawn, are available online:

'A Comment on the Zapatista "Netwar"' - David Ronfeldt and Armando Martínez

In Athena's Camp: <http://www.rand.org/publications/MR/MR880/contents.html>

Chapter Three: Networks, Netwar, and Information-Age Terrorism - John Arquilla, David Ronfeldt, and

<http://www.rand.org/publications/MR/MR989/MR989.pdf/MR989.chap3.pdf>

rug mobs

..three years later and NYC is seeing mysterious groups of citizens (with no prior knowledge of one another) coordinating nefarious spontaneous rug 'not buying' (with 10 minutes from assemblage to dispersal). They turn up at a predefined rug (creating an impromptu crowd) decide not to buy it and leave (with nothing taken or damaged).

It seems that spontaneous technologically mediated group coordination is an established (mostly understood) and widely employable tactic. For good and bad ..and good against bad ..and bad against good ..and for no particular reason or end.

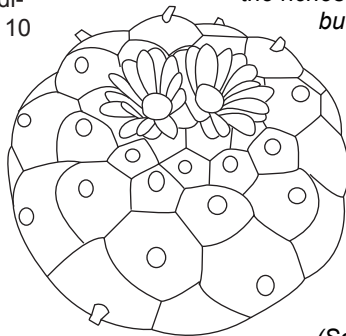

Published in 1968, the book is an account of how Don Juan, a Yaqui indian shaman, teaches Castaneda the use of various drugs in a spiritual context. It focuses on accounts of these drug experiences.

In his later books Castaneda states that his drug experiences were in fact a low order appreciation of what Don Juan was trying to teach him. Don Juan had been reluctant to indulge what was in fact Castaneda's own interest in drugs, he was teaching Castaneda to see differently, but to see in a way that did not fundamentally require the use of drugs.

drugs and the built environment

You may not be awake to your patterns

You may not be receptive to change or able to see that there are other patterns

Disruption, trauma and shock can open you and shake you out of your patterns, but they are not useful patterns in themselves

among people who have experimented with psychedelic drugs, the richest experiences are often not the drug experiences but the life they learned to live if they found a way back afterwards.

The new patterns they chose subsequently were more consciously chosen and less arbitrary

The question is, can you be awake, having never taken drugs, having never been to war, having never travelled, having never had your assumptions challenged.

(Some people can and some people can't).

drugs and the built environment

getting back down

"Nigredo is about coming down. And to come down, all the way down, takes some time. You cannot do it overnight, and you cannot do it by getting high. Nor, as the wise maintain, can you do it by reading or thinking. Body and mind must come to rest.

If you do not know the ground state intimately, how will you be able to separate the signal from the noise, during the phase of amplification."

Pharmako/poeia - Plants, Posions and Herbcraft by Dale Pendell, mercury house san francisco 1995

castaneda

The book 'The teachings of Don Juan : A Yaqui Way of Knowledge' by Carlos Castaneda functions in part as an argument for drugs waking you up and mediating a new way of seeing the space.

Acid breaks down the arbitrary stuck structural symbolism of your banal built environment

One of the functions of hallucinogenic drugs in rights of passage rituals was to show the arbitrary nature of the built and social fabric of the tribe.

People and things that are familiar, that you take for granted, through tripping become strange again. The natural [non-urban, unfamiliar] environment, which often through social conditioning becomes irrelevant and is set in opposition to the [familiar] built environment, can suddenly make more sense than the built environment [which, by comparison, can seem arbitrary and alien].

Growing up in a huge urban environment like London or New York, people can come to believe that the shape of their world is fixed and can be no other way.

The very way of doing things they are exposed to, from social patterns and constructs to architecture (literally the shape of the buildings and the fact that these buildings are there). These structures have effectively always been there and will always be, permanent and unchallengeable.

Institutions, from the banks, the schools, the shopping malls,

the police and the other symbols of structure and power, to the mundane and banal buildings they see around them, all project an image of permanence and stability.

Even their own internal patterns fall into this category.

Taking acid can break down the arbitrary imposed part of your belief systems, destroying the faith that what you have known is all there is, that there can be nothing else because you know nothing else.

There are less (or more) violent ways to achieve the same effect.

Travelling exposes you to different assumptions and different structures that challenge those you have grown up with.

going to America from the Europe you notice how everything is the same and yet different.

The scale is wrong, there are still street lamps but they look different, the mailboxes are different, the light switches, locks and taps follow different conventions.

All these things gnaw at you quietly and force you to think about the authority of your own country's vision in the presence of an alternative.

History, art and anthropology are soft forms [compared to, and not combined with, drugs and travel] which often fail to challenge because they are easy to bring your old assumptions to.

War is a hard form. It can destroy your built environment, disrupt routine and social structure, and fundamentally challenge assumptions about truth and dominance. War is traditionally a time when assumptions are challenged and new methods and patterns are let loose.

Anything which breaks down individual dependence on an imposed vision can free your mind, allowing you to think differently and outside convention.

A primary challenge acid lays down is:

This is a different way of looking at your world, much of what you believed was constant is variable.

Can you internalise this, can you take these new eyes into your normal life and see and think differently without acid? Given this violent disruption to your internal world can you find structures that make sense and are consistent in the shadow of a new perspective?

Acid is often viewed as a shortcut to a higher state of consciousness, a state which ascetics and holy men can struggle to attain throughout their lives.

A violent, unpredictable and dangerous shortcut.

The central question after you have taken this shortcut and been given a glimpse of how your mind might see, is can you get back to that state clean (without drugs)?

If someone asks whether they should take acid [a more serious decision than mushrooms for example - mushrooms are not trivial but they don't fry you in quite the same way], a flawed but sort of relevant analogy is:

'This man breaks his back and after surgery he gets to the point where he's able to do pretty much everything he could do before. You meet him later in life, you talk to him and it turns out he has learned a great deal from his experience and that he has met people and had adventures that he would not have had his life not been violently changed. But he broke his back, his life is not as it would have been had he not, he cannot go back.'

'There is risk and a cost associated with harder drugs, and some people should not or need not ask to be opened up.'

'drugs may show you the way but they don't take you there for long'

inside

"Every culture lives within its dream"

"but drink remained 'the quickest way to get out of Manchester'"

Lewis Mumford 1932

opiates

"it would more true to say that opiates became the religion of the poor."

straight

One of the beautiful things in the world is a dope fiend getting straight. They have a special radiance.

Love, a relationship, a good job, friends, all those things we call "merit" or "good karma," are part of your medicine, part of your power. You are going to need them all, but you are going to need more.

"It is hard to know that this magic carpet exists and that one will no longer fly on it"

-Jean Cocteau

The poison doctor calls upon all of his medicines and uses poisons to fight poisons. Here we part company with Twelve Step approaches. Nothing against abstinence; "whatever works," we say. But most poisoners would prefer to give up the identity of "being an addict" without taking on the new one of "being in recovery." We wish to maintain and continue the recovery that led us to poisons in the first place.

[...]

You may need to change your environment. If all of your friends are Junkies you have to move. A few members of our beloved poison clan have proved exceptions to this rule, but how many of us can pull off what the magicians do? Your ally will tell you.

Having kicked one addiction does not make you immune. In fact, if you fall again you will be worse off than before. Every magician can survive one bottoming out, by definition. Don't tempt the Fates.

"A man who, after having long been in the power of opium or hashish, has succeeded, despite his enfeeblement by the habit

of slavery, in mustering the necessary energy for his deliverance, seems to me like an escaped prisoner. He inspires me with more admiration than the prudent man who has never lapsed, having always been careful to avoid temptation.”

- Charles Baudelaire, *The Poem of Hashish*

Truly poisonous words.

Pharmako/poeia - Plants, Posions and Herbcraft by Dale Pendell, mercury house san francisco 1995

Where Everything Comes From

“That ugly crumpled upper surface of yours, that cerebral cortex, is almost nonexistent in lower animals, but once you got the hang of evolutionary growth and a taste of the inflated abstract thoughts you could make with that cortex, you enlarged it and enlarged it until it became eighty percent of your volume. Then you started cranking out rarefied ideas as fast as you could crank them, and issuing commands to helpless appendages like me, forcing us to act on those ideas, to give them form. Out of that came civilization. You willed it into being because, with your cortex so oversized and all, you lost your common ground with other animals, and especially with plants; lost contact, became alienated and ordered civilization built in compensation. And there was nothing the rest of us could do about it. You were holed up there in your solid bone fortress, a cerebrospinal moat around you, using up twenty percent of the body’s oxygen supply and hogging a disproportionate share of nutrients, you greedy bastard; you had hold of the muscle motor switches and there was no way any of us could get at you and stop you from spoiling the delight of the world.” (*Even Cowgirls Get The Blues*)

The above conversation took place between the thumb and brain in *Even Cowgirls Get The Blues*, and gives the reader a good idea of what I am referring to in this section. The cerebrum and cerebral cortex are what separates us from the rest of life on earth, and rules almost all we see. The brain stem, however, has remained unchanged throughout time, and is perhaps our only link to our environment.

[Thanks to the writer of the FAQ this came from]

amoeba Knowledge

‘I woke up after acid and (aside from trying to wash it off and crying) what was burnt into my head was: well if its like that, then that changes everything. How can I get back there clean.’

[psychiatrists used to report successfully treating alcoholism with acid][long difficult road back from either]

take away my dreams before they damage me any more.

‘acid stole the neurotic fire that was holding me up. Damned before, damned after.’

‘most of the things I know are negations, things I know not to do’ [amoeba knowledge].

a chemical shock

How can you tell if you are lucky? In his letter to the Romans, Paul is clear that he has two teachings, that there is an exoteric path and that there is an esoteric path. He states unambiguously that he knows that all substances are by nature pure, that Jesus told him so. The issue then is stumbling. Another’s stumbling. Another who does not understand that all substances are pure

With the very poison, a little of which would kill any other being, a man who understands poison would dispel another poison.

Hevajra Tantra

The Poison Path is the narrow way, the twisting path, or no path at all. You could make it, O Nobly Born, you just might survive, yes, but who could follow you? Better to send them down the big road, well trodden and paved; this Poison Path is no shortcut. The Poison Path is best suited to tricksters and magicians who, if the stories are to be believed, come back to life after getting killed.

If you don’t feel like a normal person until you snort H this is a sign that - well, a bad sign. A sign that you must avoid it, immediately; that the prognosis of your relationship with this particular ally is poor.

Such people should take Prozac, not heroin.

“They love not poison that do poison need.” - William Shakespeare, *Richard II*

“He not busy being born is busy dying,” as Bob Dylan put it.

from *Pharmako/poeia - Plants, Posions and Herbcraft* by Dale Pendell, mercury house san francisco 1995

dissent

the countercultural idea has become capitalist orthodoxy

“The ways in which this system is to be resisted are equally well understood and agreed upon. The establishment demands homogeneity; we revolt by embracing diverse, individual lifestyles. It demands self-denial and rigid adherence to convention; we revolt through immediate gratification, instinct uninhibited, and liberation of the libido and the appetites”

“The countercultural idea has become capitalist orthodoxy”

“ersatz rebellion everywhere on TV”

“..drives the machine by invading the sanctum of every possible possible avant-garde”

“now we are sold cars by an army of earringed, dreadlocked, goateed, tatoood, and guitar-bearing rebels”

“Capitalism has changed dramatically since the 1950’s, but our understanding of how it is to be resisted hasn’t budged

“The most startling revelation to emerge from the [William S.] Burroughs/Nike partnership is not that corporate America has overwhelmed it’s cultural foes or that Burroughs can remain

'subversive' through it all, but the complete lack of dissonance between the two sides.'

"Avant-garde was becoming tradition: what had been dissonance a few years before was turning into a balm for the ears (or for the eyes)"

psychedelic concentration camp

"reality did not cease to exist, of course, but much of what people understood as reality, including virtually all of the commercial world, was mediated by television, it was as if a salesman had been placed between Americans and life."

"we seem to have no problem with the fact of business control over every aspect of public expression"

'DARK AGE - Why Johnny Can't Dissent' by Tom Frank, published in The Baffler

dissent

Tom Frank, in his essay 'Dark Age - why johnny can't dissent', attacks the ineffectiveness of a compromised counterculture which failed to evolve from it's roots in the 1950's and 60's.

tom frank

"It was indeed the age of of information, but information was not the precursor to knowledge, it was the tool of salesmen"

"where citizens are referred to as consumers"

"The American economy may be undergoing the most dramatic shifts in this century, but for the past thirty years people in music, art, and culture generally have had a fixed, precise notion of whats wrong with American life and the ways in which the responsible powers are to be confronted. It is a preconception shared by almost every magazine, newspaper, TV host, and rock star across the alternative spectrum. And it is the obsolescence and exhaustion of this idea of cultural dissent that accounts for our singular inability to confront the mind-boggling dangers of the information age."

"The ways in which this system is to be resisted are equally well understood and agreed upon. The establishment demands homogeneity; we revolt by embracing diverse, individual lifestyles. It demands self-denial and rigid adherence to convention; we revolt through immediate gratification, instinct uninhibited, and liberation of the libido and the appetites"

"The countercultural idea has become capitalist orthodoxy"

"ersatz rebellion everywhere on TV"

".. drives the machine by invading the sanctum of every possible possible avant-garde"

"now we are sold cars by an army of earringed, dreadlocked, goateed, tatoood, and guitar-bearing rebels"

"Capitalism has changed dramatically since the 1950's, but our understanding of how it is to be resisted hasn't budged"

"The most startling revelation to emerge from the [William S.] Burroughs/Nike partnership is not that corporate America has overwhelmed it's cultural foes or that Burroughs can remain 'subversive' through it all, but the complete lack of dissonance between the two sides."

"Avant-garde was becoming tradition: what had been dissonance a few years before was turning into a balm for the ears (or for the eyes)"

[psychedelic concentration camp]

"to fabricate the materials with which the world thinks"

"reality did not cease to exist, of course, but much of what people understood as reality, including virtually all of the commercial world, was mediated by television, it was as if a salesman had been placed between Americans and life."

"we seem to have no problem with the fact of business control over every aspect of public expression"

'DARK AGE - Why Johnny Can't Dissent' by Tom Frank, published in The Baffler

chemical anchors

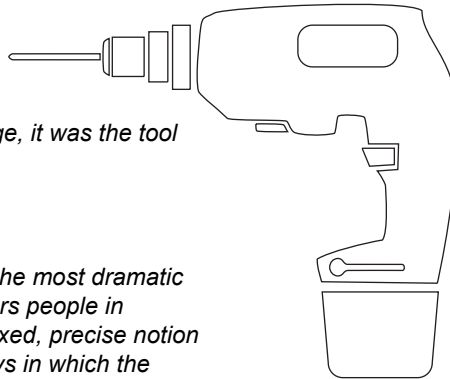

"note that the audience's untitled, emotional farmland is a single-use commodity that will be recapitalized by many industries external to the "music" industry

imprinting certain songs on the brains of a teenage audience during their formative years serves as a selection mechanism for future radio stations, commercials, period movies, etc

the period of harvesting the fruit of these early seeds is when the onetime teenagers reach their early-thirties - old enough to have earning power, young enough to have disposable income (low chance of mortgages, kids, etc).

the teenagers' attention should be treated as part of a transaction ... companies that engage said attention are benefiting from a (re)transmission medium for which they are never billed ... and can never be reused ... formative memories (imprinted on virgin minds) are never lost or less intense than their successors.

songs are like links in blogs ... molecules that anchor chemical reactions, given appropriate catalysis ... they are chrono-emotio-spatial hash signatures by virtue of early binding to formative experiences

the limited resource, the economic resource is not the songs ... it's the formative experiences ... which are being sold in an invisible transaction that commits the memory's owner to a lifetime of subsequent heartstring-pulling ... unpaid and involuntary.

the music industry can and does make money by selling performance rights to these songs, into infinity ... even if _all_ the songs were given away for free on P2P networks ... they are an anonymous sorting mechanism ... the only problem is the 17-year gap between binding the song to a memory and harvesting the disposable income of the memory's owner." Rich Persaud

seeming vs being

Broadly speaking, ideas can evolve to seem true or they can evolve to be true

"For the magicians not only believed in marvels but audaciously sought to work them: by their straining after the exceptional, the natural philosopher who followed them were first given a clue to the regular."

"The dream gives direction to human activity and both expresses the inner urge of the organism and conjures up appropriate goals."

"Everywhere the dross of fraud and charlatanism mingled with the occasional grains of scientific knowledge that magic utilised or produced."

"If gold did not come out of lead in the experiments of the alchemists, they are not to be reproached for their ineptitude but congratulated on their audacity: their imaginations sniffed quarry in a cave they could not penetrate, and their baying and pointing finally called the hunters to the spot."

"..to have dreamed so riotously was to make the technics that followed less incredible."

Lewis Mumford

absorption

acceptance

absorption

co-option

continued resistance

banality

[children]

"so opaque to so many things yet so keen to the tactics of media manipulation"

[adbusters, the baffler][plastic gods]

Khaosan road

But for all its color, Khaosan Road [epicentre and crossroads for backpacking world travellers] is more than a curiosity. It is a raucous, round-the-clock wake for a way of life that is gone forever. It is the black hole at the center of a shrinking world where the Age of Discovery has ended, all roads have been traveled and the words "remote" and "exotic" have all but lost their meaning." The travelers have changed as well; indeed, the whole enterprise of rough travel has changed. In many ways, it has become as regimented as a standard package tour. The sandals, the strange hair and the tie-dyed shirt are no longer a cry of rebellion, as they were in the 1960's and 70's. They are now the gray-flannel suit of the budget traveler, following in 30-year-old footsteps in search of enlightenment: eating the same food, listening to the same music, making the same discoveries. The T-shirts display the grip of conformity from one generation to

the next: familiar portraits of Che Guevara, John Lennon, Bob Marley, Mao Zedong, Kurt Cobain and an American Indian chief." Young Moses Fletcher, 23, from Britain looks exactly like mature Wolfgang Maria Ohlheuser, 60, from Germany, with their loose white cotton outfits, beards and sandals, except that Mr. Ohlheuser's beard is white." And what is there left for these travelers to discover? The recipe for adventure can now be found in a guidebook, like the ingredients for a chocolate cake - every dirt trail, every hill-tribe village, every night market, every guest house, every glorious sunrise. The world of travel has been tamed. The last few rough patches in Asia are being nibbled away now: the northern edges of Laos, the plains of southwestern China, the hidden villages of northern Myanmar. Even the remotest of these have been mapped, analyzed and assessed for their curiosity quotient in the guidebooks."

'Bangkok Journal: Bit of Trekkers' Exotica, Looking More Like Home' By SETH MYDANS

reality

"who says the streets are reality? We call a fresh bunch of crackheads an episode"

Kash

"And his tale at the beginning was like the hashish that makes people happy when awake; then it became like the hashish of a dreamer.

His words were at first as sweet as honey, his voice penetrating the multitude as the first rain of summer parched earth. From his tongue there went forth a perfume more exquisite than must or incense: his head shone like a light, the only luminary in a black night. And his tale at the beginning was like the hashish that makes people happy when awake; then it became like the hashish of a dreamer. Toward morning he raised his voice, however, and his words swelled like the rising Nile in the hearts of the people: they were for some as pacifying as the entrance into Paradise, but as frightening for others as the Angel of Death. Joy filled the spirits of some, horror the hearts of others. And the closer the moment of dawn, the more powerful became his voice, the louder it's reverberations within the people, until the hearts of the multitude reared against each other as in a battle; stormed against each other like the clouds in the heavens of a tempestuous night. Lightening blots of anger and thunderclaps of wrath collided.

But when the sun rose and the tale of Far-li-mas closed, unspeakable astonishment filled the confused minds of all; for when those who remained alive looked about them their glances fell upon the priests - and the priests lay dead upon the ground."

Kash legend fragment from *The Masks of God*, Joseph Campbell

a new form of difference

...but a new form of difference and dissent is emerging, A couple of examples would be the Open Source movement and the IMC (Independent Media Collective). The premise for this new form of dissent is constructive rather than oppositional, it is about building rather than stance.

In collectively developing Linux, the Open Source community have built an operating system which rivals Microsoft Windows,

and Windows is a product that has made Microsoft the most successful commercial organisation on the planet.

The IMC has created a world wide news network. Ordinary people can bypass or supplement the mainstream media, and, where they are involved in events, contribute what they have seen and heard.

Both Linux and the IMC are examples of new forms of collectively constructive community made possible by computer networks. Both have relatively flat, contribution and merit based hierarchies.

Computer networks allow opposition to organise, but more interestingly they make possible new forms of autonomous community and collective construction.

Location aware devices and the ability to mark and annotate real spaces will dramatically extend the possibilities for collective construction.

Dissent is really the wrong word. Building is a better one.

The accelerating spread of wireless network nodes, the informal coordination of community networks by groups like Consume in the UK and NoCat in California and the higher level self organising of those groups through organisations like freenetworks.org. The realisation that wireless network nodes can broadcast location information [as an RDF feed for example]. The onset of next generation cell phone networks with advanced positional functionality and chip level GPS being built into phones, handhelds, laptops and wearable. The combination of proximity awareness, live, social, peer to peer wireless connectivity, and GPS. That is the geomesh we are building around ourselves. Means that a spontaneous bottom up (rather than top down) heterarchical, network organisation will soon be the easiest social structure to configure and apply effectively to almost any given problem.

It's not a question of the edges or something to oppose its a question of conditions and structure and allowing them to change consensually and constructively

Extra-geographical states based on common interest, with their own constitutions, currency, taxation, banks etc. Communities able to collectively reinterpret the real physical world around them. Marking, demarcating and annotating real space using networks they will live in a world of agreed upon and engineered meaning that people outside the community will not see.

'build amidst the confusion of others'

prototyping future community

experimentation continues

alternative spatial, social and economic structures are continually being proposed, prototyped and explored.

new tools make this process faster and easier than ever before.

Experimentation continues: Burningman, Linux, Tinderbox, Valence, Geourl, Oracle Spatial, next generation cell phones, pervasive wireless connectivity, gps chips, personal navigation systems, MicroOptical, IBM, WEM, MIT borglab, dorkbot, Waag, SpaceHijackers, social software, hydra, rendezvous, geocaching, noderunner, RDF, FOAF, advogato, affero, Consume, Nocat.

From research labs to distributed coding collectives, from ad hoc social networks to people finding unexpected uses for the devices in their pockets.

From Latvia to California, new, and experimental ways of thinking, connecting and interacting are having a real impact on possibility.

charred coughing phoenixes

..resurrection

The combination of high bandwidth internet access and location aware wireless devices facilitates a medium, the geomesh, capable of borrowing all the existing metaphors and applications that have evolved around each of its parents, plus whole other rich seams of untapped potential ways of thinking about and using this technology.

Real world problems, theory from architecture, from simulation, from linguistics, anthropology and psychology, ideas from science fiction, literature and mythology, all offer countless new ways to think about how this technology might evolve.

Add a geographical layer to the internet and it changes what the internet is

a whole new internet.

desirability

There are as many different ways in which soft augmentation will be packaged as there are demographic groups..

Professionals, researchers, organised crime, urban youth [...]"

like all technology it is double edged, good and bad, interesting and banal, optimistic and depressing

..but it is different and it is happening.

'the extended-me culture'

'and when people sees the systems everybody will want one'

gropius (again)

"who will build gardens out of deserts and pile up wonders to the sky." Gropius

marble well governed cities

[again]

She looked over his shoulder

For vines and olive trees,

Marble well-governed cities

And ships upon untamed seas,

But there on shining metal

His hands had put instead

An Artificial wilderness

And a sky like lead.

W.H. Auden

shape of the system

..the shape of the system will be determined by what happens next.

while we're waiting for the coming revelations in biotechnology and nanotechnology, location aware devices and wireless networking, the geomesh, which looks like the banal and tedious relation of overhyped internet technologies, is actually going to change the shape of the world more completely than the internet and cell phones have..

most minds

"most mens minds remained at a medieval level. But it is the minds of the elect who constitute the differentia between one age and another."

space hardware

"It's wrong to wish on space hardware"

so

people talk to themselves

the trees sing

the buildings speak

there are notes in boxes that are empty.

Cell phones become internet enabled and location aware, everything in the real world gets tracked, barcoded and mapped.

Overlaying everything is a whole new invisible mesh of textual, visual and audible information. This information becomes available as you get close or when you ask.

availability

Consumer orientated, mobile, peer to peer and internet connected devices which are location aware (that is capable of determining and transmitting their current geographical location) or easily connected to something that is becoming available, the software to connect them up in interesting ways is already available.

There is pressure from the people and corporations and government; each wanting to move this stuff forward for their own multifarious reasons (social networking, cash, E911).

geography as context and constraint

Since the internet began its exponential growth, it has been easier for ordinary people to ignore geography as a constraint, communicating, organising and coordinating actions across borders and boundaries both artificial and real, using ideas and common interest rather than proximity as an organising principle.

cell phones

The second notable explosive growth curve charts the adoption of cell phones.

Cell phones set you free in a different sense, they allow you to communicate from anywhere.

The integration of internet access (high bandwidth peer to peer wireless networking) as a basic component of cell phone functionality, together with location awareness (the cell phone knows its geographical location or what it's close to) is leading somewhere.

The step beyond ideal, but dislocated, communities, is adding this geographical layer to the mobile internet. A spatially aware network, whether accurate (longitude and latitude) or informal (a rough indicator of proximity), means that proximity could again become a pervasive, useful but not constraining, utilitarian factor in organising community or in searching for information.

geography has not mattered

geography is unimportant on two counts.

i. It doesn't matter where you are - because the internet makes distance irrelevant in the context of communication or information retrieval.

ii. It doesn't matter where you are - because you can access the internet from wherever you are.

geography doesnt matter

"It has become clear that, thanks to the internet, geography matters less and less" Wired Magazine - March 2000

i need a sandwich

but if you are moving and have a device that is location aware and connected to the internet..

Geography is an essential added filter

it provides a context for your needs

neo: I need a sandwich, I'm not prepared to walk more than a 200 metres

operator: knock on the door of number 17 and mrs jones will make you a sandwich if you do the washing up

mass market wearable hardware

The e911 requirements called for a new generation of location aware wireless devices.

The hardware aspects of this technological revolution have been available to the military, to large businesses and the scientific community for some time.

The technology, and the geographical state of mind, has now filtered down from the yachting community and more recently from backpackers and car owners.

A GPS is now a chip level commodity item (you can add it to anything). Powerful wireless network cards are commodity item. Handheld computers and over specified cell phones are commodity items.

It is already possible to annotate space.

- a). work out where you are, find the coordinates (GPS or a web based address to coordinate converter)
- b). write a note, include the location
- c). publish an RSS place feed

You become a part of a distributed place database that is already growing rapidly and being mined.

Leave a note at that geographical location.

It's not that hard and it's getting easier.

by adding geographical awareness to the internet you create something new

...this is the last place I saw my father before he died.

The concept is an extension of a cartesian system and yet the point in space specified may link to an emotional state rather than a cold label.

You could search for sadness in New York.

The whole world will become an annotated space, which links from the real to the information space and back again. The world as interface.

You can search locally based on your current position,

e.g. show all the restaurants within a mile radius.

The device knows where you are and the database knows what's close by.

peer to peer is more interesting than broadcast models

It is already possible to broadcast information, for example the location of the nearest Starbucks, but life becomes more interesting when consumers can contribute information.

..show me all the restaurants my friends like within a mile radius.

The structure becomes interesting when ordinary users can annotate that database.

At that point the database grows and the users direct its uses, they determine the future business models for such an infrastructure.

You are driving down the main street of an unfamiliar town and all you can see is the shops and buildings on either side. You are effectively in a valley and all your information about the place is constrained by line of sight.

The map on the display of your mobile device however is lit up with dots which represent places of interest determined by the network Starbucks, McDonalds, 76 etc.

A more interesting case: the information you are receiving is not just a broadcast that lists the nearest Starbucks and McDonalds, but information based on your personal profile and the suggestions and opinions of your peers.

The places that you might be actually be interested in that you can't see are now visible and accessible to you.

Alternative bookshops, Yoga studios, old friends or whatever

Factor in everybody and their contributions and opinions, and you radically empower the system.

Conventionally in a city you would maybe know only a very few of your neighbours and mostly in the same street, your wider community is present, but currently invisible and inaccessible.

Sitting at home bored, you check your device and it indicates that someone you haven't met, but who has a friend in common, is sitting at home two streets across and three houses down and they are also bored.

Members of distributed communities held together by common interest could be made more aware of who within those communities is physically local to them.

headgames

Assume kids have cell phones that transmit their geographical coordinates

Computer games evolve that actually get kids out of the house and running around instead of being stuck in front of a computer

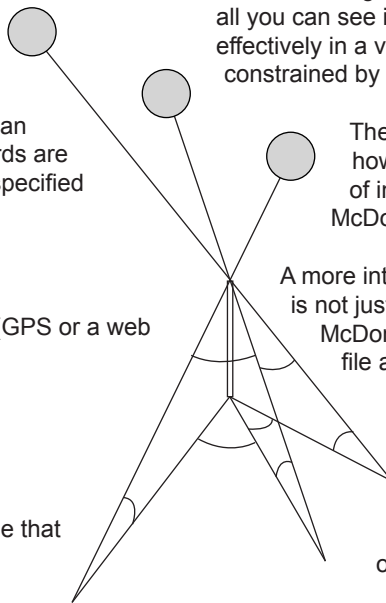

screen.

Gaming stress tests technology and defines ways in which it can be used effectively (businesses for example will end up making use of the innovations that designers of these games instantiate).

'go to the end of their road and climb onto the roof of the abandoned cinema' (or whatever; localization involves user contribution)

..when the device transmits the coordinates of the top of the cinema the game gives them with the next problem... (add a time component: run to the end of the road and climb onto the roof of the deserted cinema)

Extending phone functionality:

status messages on phones

By the side of each of the names on your cell phone's people list appears a status message: bored, busy, in transit etc.

Once people are logging their location in such a way that their friends can find them, you could be notified if your friends came within a mile radius of your current location

Parking space finding, homeless people are given free devices to log parking spaces as they become available (and receive payment)

Entering a restaurant you see a huge burning skull in the middle of the room. Nobody else sees it. The skull was left at this geographical location by one of your peer group indicating that the restaurant is terrible.

..a box in a room may have something in it even though it is empty.

wanting (emotional archaeology)

know when your friends are near

know when something happens close by

spontaneous organization and disorder flows

[everyone within a mile radius here now]

publish your morning walk somewhere

meeting places invisibly sign posted [skateboard here wednesdays]

uses beyond utility

[...]

know where the nearest starbucks or mcdonald's is.

[...]

I want to find the echoes of the people who have been here before me

emotional archeology

geography adds a whole new dimension to the internet

information is actively overlaying real space

all the problems relating to building such an infrastructure have been reduced to resolution rather than possibility or plausibility.

but free, open, secure and contribution based ?

wireless castenada

invisible allies

trees hum

rooms answer questions about themselves

life flows into inanimate objects

its a weird occult project and nobody seems to have noticed

like all those roman gods for everything

society is actively looking for new ways to organise

Society is actively looking for new ways to organise, and questioning ideas of value and exchange [inertia created by dominant power structures].

Location awareness offers a radical new way to organise and augment communities.

a united states, freedom, representative democracy

There is an array of entirely new ways of doing things, and we're just beginning to see that a lot of them can be linked together to make even newer ways of doing things.

The ideas behind the western representative democracies have not been allowed expression in terms of modern capabilities.

Those original ideas found expression in the structures that have come down to us, but those structures were defined in the context of the technological capabilities of the times.

Western representative democracies were fixed as a way of doing things at a point in time when reaching the place where discussions were held and decisions were made involved days or even weeks of travelling on horses. The only way to be represented was to send a representative.

Nobody seems to have noticed that conditions have changed, or at least they are unwilling to discuss reform.

the new economy

Things are still getting weirder.

The recent collapse of the new economy stocks, does not represent the end of technological change.

The underlying value generated by the internet was not bound up in companies like amazon which hold up big signs that say 'we are the internet' (which they plainly are not) but in the broader effects on society and the economy of a wider range of communications technologies (the internet, email, web accessible databases, wireless communications) and wider access to, and applications of, those technologies.

The new economy fed off the experimentation of marginal communities (the military, academics, the open source community, the counter-culture and the porn industry) that were using the internet before the rest of the world got interested and who won't stop working on what interests them because the stock market woke up to it's own confusion.

From the point of view of the more interesting new economy experimentation, those years have been compared to the punk movement (in the sense that it gave people who would never otherwise have been in bands a chance to get up on stage and play ..however badly). The repercussions of punk are still being felt. The repercussions of the new economy with the subversive questions it raised (and to a large extent failed to answer) about how things could be done, who should have the power, what is valuable and where we should be going, are still to be determined.

The ongoing argument is a longer term one and it isn't over. If nothing else the money didn't all entirely disappear. Infrastructure, software and new ways of doing things are being absorbed by society and traditional industry.

..ten years ago no one had a cell phone, email or a web browser. You couldn't find what you needed or talk to the people you wanted to talk to (and now you can), national boundaries were barriers to the flow of information.

..and the new stuff won't go away just yet, because the money got spent, the infrastructure was bought and installed, and the system that allowed the whole thing to happen in the first place was designed to withstand a nuclear attack, a more serious threat than an economic slow down.

..if things can move just a little further ordinary people will find themselves with internet connected cell phones (high speed connections and fast processors) that know where they are.

Times have changed.

reinterpreting anarchy as a positive and constructive relative of heterarchy

Anarchy and heterarchy are potentially a state of grace rather than a grave synonym for destructive disorder.

Anarchy (the organisational idea rather than the usual associations) has survived the 20th century in better shape than other

ideological labels. Despite being branded with a raft of negative associations at the hands of centralising and controlling forces, and falling into the hands of the purely disruptive and destructive, anarchy (reinterpreted) potentially has something positive to say that new technological and social conditions finally make relevant.

A hybrid of heterarchy and anarchy could mean a network and infrastructure that would allow, integrated, but separate constructive communities to be autonomous, independent, interdependent, and free. A further iteration on the ideas of the founders of the united states for example.

Anarchy and heterarchy are brothers, and they do not, despite what you may have been told, necessarily mean you any harm. They can fix problems that other systems can only hide from.

prototyping future community

..follow the form of Dee Hock (the man behind Visa) and other radical but realistic thinkers, build a network of similarly motivated companies and financial services

make that network the corner stone of a community that will be able to keep it's financial and non-financial transactions in line with a core of commonly held beliefs by keeping those transactions inside the community network.

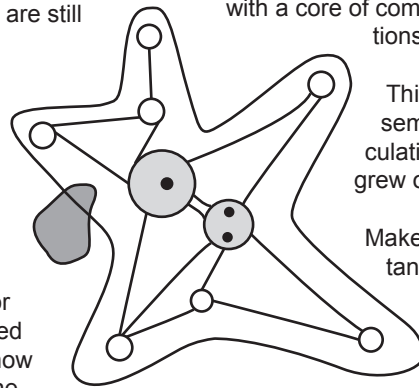

This is an old idea, immigrant communities often semi-formalise the idea of keeping their dollars circulating inside their communities. Cooperative banks grew out of socialist ideas.

Make mobile and location aware devices an important part of your thinking.

[maybe find some next generation hardware and software, intended ultimately for general consumption, preferably at the point when it is being developed, tested and perfected and convince the developers to make your network its first customer].

Then conceive of this community in terms of a non-geographical state thats always locally aware, where membership gives you access not just to conventional services but also the rest of the community ..and the community infrastrucutre: experiment with new ideas of value and exchange, share houses, cars, food and ideas.

Potentially a digitally mediated 21st century extended commune

There are people who are quietly doing all this stuff.

..the same ideas could equally be employed by the Aryan nation.

better ways

Disenfranchised and alienated communities are suffering a huge and present hangover in the form of the blunt instruments of the 20th century. Money, mass production, centralisation, mass media focused on broadcasting rather than dialogue, government by force aligned to the threat of total war and nuclear annihilation, government sanctioned by a token vote every five years, government sustained by involuntary taxation.

It seems difficult to imagine these ideas being marginalised, but formerly dominant forces going much further back have been reduced to symbolic roles, displaced by new forms of social organisation rather than directly defeated.

Change for good is coming up with something better, not shouting abuse from the sidelines.

..its about plumbing, not revolution. Plumbing can be political, but its a largely inclusive form of politics.

Better means of exchange

Better community tools

Better interfaces to local spaces

revision note

..at the time of writing this partial revision of the original headmap manifesto there are an estimated 500,000 weblogs with Geourl place tags indicating their location. Thoughts implicitly associated with places

There are already geo-search engines mining these weblogs

You can search for sadness in New York.

The beginnings of the people level geomesh are already visible.

Ad hoc wireless networks (technologies like Rendezvous). Tools for collaborating with others close by (like Hydra). Static wireless network nodes broadcasting positional information (RDF place feeds).

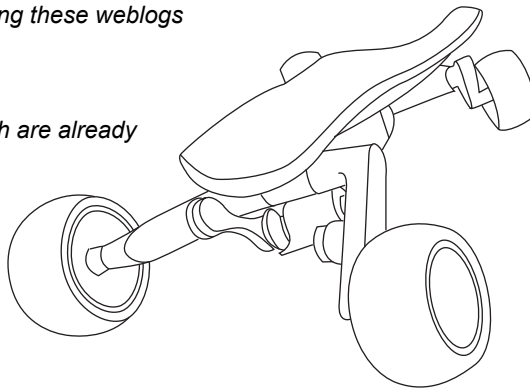

Proximity and position interacting.

There are tools on the way to the mainstream (already available) that will make creating personal place feeds easy for ordinary people. In fact using next generation of semantic web authoring and navigation tools (not relatives of conventional browsers - more like Mark Bernstein's Tinderbox or Danny Ayers' Ideagraph) adding a place attribute (geographic metadata) to any kind of data entity (email, images, notes, websites) will be easy for anyone.